



Life Sciences

Validation Guide

USTR 2114⁽²⁾

Validation Guide for Pall[®] Emflon[®] PFR Filter Cartridges

CONTENTS

Part I. Overview	4
1. Introduction	4
2. Summary of Conclusions	4
Part II. Studies on Removal Efficiency	6
1. Microbial Validation using <i>Brevundimonas diminuta</i> Liquid Challenge Tests	6
1.1 Introduction	6
1.2 Summary of methods	8
1.3 Results	10
1.4 Conclusions	13
1.5 Microbial validation of other styles of Emflon PFR filters	15
2. Aerosol Bacterial Retention Tests using <i>Brevundimonas diminuta</i>	22
2.1 Introduction	22
2.2 Summary of methods	22
2.3 Results	23
2.4 Conclusions	24
3. Long-Term Aerosol Microbial Challenge Tests	25
3.1 Introduction	25
3.2 Summary of methods	25
3.3 Results	27
3.4 Conclusions	28
4. Bacteriophage and Spore Aerosol Challenge Tests	29
4.1 Introduction	29
4.2 Summary of methods	29
4.3 Results	30
4.4 Conclusions	31
5. Sodium Chloride Aerosol Challenge Testing	32
5.1 Introduction	32
5.2 Summary of methods	32
5.3 Results	33
5.4 Conclusions	33

Part III. Validation of Physical Characteristics	34
1. Resistance to Steam Sterilization	34
1.1 Introduction	34
1.2 Summary of methods	34
1.3 Results	35
1.4 Conclusions	37
2. Resistance to Vaporized Hydrogen Peroxide	38
2.1 Introduction	38
2.2 Summary of methods	38
2.3 Results	39
2.4 Conclusions	39
3. Resistance to Hot Air	40
3.1 Introduction	40
3.2 Summary of methods	40
3.3 Results	40
3.4 Conclusions	42
4. Air Flow/Differential Pressure Characteristics	43
4.1 Introduction	43
4.2 Summary of methods	43
4.3 Results	43
4.4 Conclusions	44
5. Water Flow/Differential Pressure Measurements	45
5.1 Introduction	45
5.2 Summary of methods	45
5.3 Results	45
5.4 Conclusions	45
Part IV. Extractables and Biological Safety Testing	46
1. Extractables Testing of Emflon PFR Filters	46
1.1 Introduction	46
1.2 Summary of methods	46
1.3 Results	47
1.4 Conclusions	48
2. Biological Safety Tests on Components of Emflon PFR Filter Cartridges	48
2.1 Introduction	48
2.2 Summary of methods	49
2.3 Results	49
2.4 Conclusions	49
Appendix 1	50

Part I. Overview

1. Introduction

This report contains validation data applicable to Pall microbially-rated **Emflon** PFR filter cartridges. **Emflon** PFR filters contain proprietary PTFE filter membrane and they are designed for sterilizing air and gas applications. **Emflon** PFR filters may also be considered in some liquid applications.

This report is designed to assist the filter user in meeting the validation requirements of regulatory authorities within the pharmaceutical industry.

2. Summary of Conclusions

Part II. Studies on Removal Efficiency

Emflon PFR filters were tested using liquid challenge tests using *Brevundimonas diminuta* (ATCC 19146), in accordance with the FDA guidelines on Sterile Products produced by Aseptic Processing (1987). These tests demonstrated that **Emflon** PFR filters retain 10^7 *Brevundimonas diminuta* per cm^2 in liquid.

Forward Flow and water intrusion integrity tests were shown to be suitable non-destructive integrity tests for **Emflon** PFR filters, and test parameters correlated to liquid bacterial challenge tests have been set.

Various aerosol microbial challenge tests were also performed on typical production filters. These tests demonstrated that **Emflon** PFR filters retain high levels of aerosol bacteria, bacteriophage, spores and sodium chloride particles. A summary of the aerosol challenge data is shown below:

Aerosol Challenge Suspension	Direction of Flow During Challenge Test	Result
<i>Brevundimonas diminuta</i> (ATCC 19146)	Forward ('out to in')	$T_R^* > 2.29 \times 10^9$
<i>Brevundimonas diminuta</i> (ATCC 19146)	Reverse ('in to out')	$T_R^* > 3.10 \times 10^8$
<i>Brevundimonas diminuta</i> (ATCC 19146)	Forward – 30 day test	$T_R^* > 6.8 \times 10^{10}$
Bacteriophage PP7	Forward	$T_R^* > 2.4 \times 10^{11}$
Bacteriophage MS-2	Forward	$T_R^* > 2.3 \times 10^{11}$
<i>Bacillus subtilis</i> Var niger spores	Forward	$T_R^* > 2.3 \times 10^{10}$
<i>Bacillus subtilis</i> Var niger spores	Forward – 30 day test	$T_R > 2.6 \times 10^{10}$
Sodium chloride	Forward	Data supports a gas rating of 0.003 μm

* T_R Minimum titer reduction observed during testing

Part III. Validation of Physical Characteristics

Resistance to Steam Sterilization

Emflon PFR filter cartridges have been demonstrated to retain integrity after repeated steam in place cycles, under the conditions listed below:

Test	Temperature	Steam Flow Direction	Cycle Time	Differential Pressure	Total Steam Exposure
A	142°C (288°F)	Forward	11 hours	< 300 mbar (4.3 psid)	176 hours
B	142°C (288°F)	Forward	1 hour	< 300 mbar (4.3 psid)	165 hours
C	125°C (257°F)	Forward	1 hour	1000 mbar (14.5 psid)	30 hours
D	125°C (257°F)	Reverse	1 hour	500 mbar (7.2 psid)	40 hours

Resistance to Hydrogen Peroxide Vapor

Emflon PFR filters demonstrated excellent resistance to vaporized hydrogen peroxide and may therefore be considered for applications where sterilization by vaporized hydrogen peroxide is required.

Resistance to Hot Air

The data presented demonstrate that **Emflon** PFR filters withstand exposure to air at elevated temperatures. Based on cyclic exposure to steam and hot air, the results indicate that **Emflon** PFR filters will retain integrity following exposure of well over one year at 60°C (140°F).

Air Flow/Differential Pressure and Water Flow/Differential Pressure Measurements

The relationship between air flow and differential pressure was investigated using typical production filters at different flow rates and inlet pressures. Water flow rates at set differential pressures using alcohol-wetted filters were also determined. The data obtained during these studies can be used to form the basis of sizing calculations for the use of **Emflon** PFR in gas and liquid service.

Part IV. Extractables and Biological Safety Testing

The gravimetric residue after flushing autoclaved filters in a number of extracting fluids was determined using typical production filters. A summary of the results obtained is shown below:

Extraction Fluid	Residue per 25 cm (10") Filter
Deionized water	1 – 3 mg
Isopropyl alcohol	15 – 17 mg
Ethanol	34 – 59 mg
Diethyl ether	382 – 559 mg

Emflon PFR filter cartridges were found to meet the requirements of the USP for Class VI (121°C) Plastics.

Part II. Studies on Removal Efficiency

1. Microbial Validation using *Brevundimonas diminuta* Liquid Challenge Tests

1.1 Introduction

The FDA guidelines on Sterile Products Produced by Aseptic Processing (1987) state, 'A sterilizing filter is one which, when challenged with the micro-organism *Pseudomonas diminuta* (*P. diminuta*), at a minimum concentration of 10^7 organisms per cm^2 of filter surface, will produce a sterile effluent'.

In order to meet the requirements of this guideline, liquid challenge tests using *Brevundimonas* (*Pseudomonas*) *diminuta* (ATCC 19146) were performed with **Emflon** PFR filter cartridges using a minimum of 1×10^7 colony forming units (CFU)/ cm^2 of effective filtration area.

The correlation between microbial retention and a non-destructive integrity test is also an important aspect of the validation of sterilizing grade filters. The FDA guideline further states, 'After a filtration process is properly validated for a given product, process and filter, it is important to assure that identical filter replacements (membrane or cartridge) used in production runs will perform in the same manner. One way of achieving this is to correlate filter performance data with filter integrity testing data'. The integrity tests used during this validation study were the Forward Flow and water intrusion tests.

The Forward Flow Integrity Test

In the Forward Flow test, a filter is wetted with a suitable test liquid and a pre-determined gas pressure is applied to the upstream side of the filter assembly. After a stabilization period, the gas flow through the wetted membrane can be measured manually on the downstream side or on the upstream side, using sensitive flow measurement equipment such as the Palltronic® Flowstar or Palltronic Aquawit filter integrity test devices, as shown in figure II-1.

Figure II-1 The Forward Flow Integrity Test

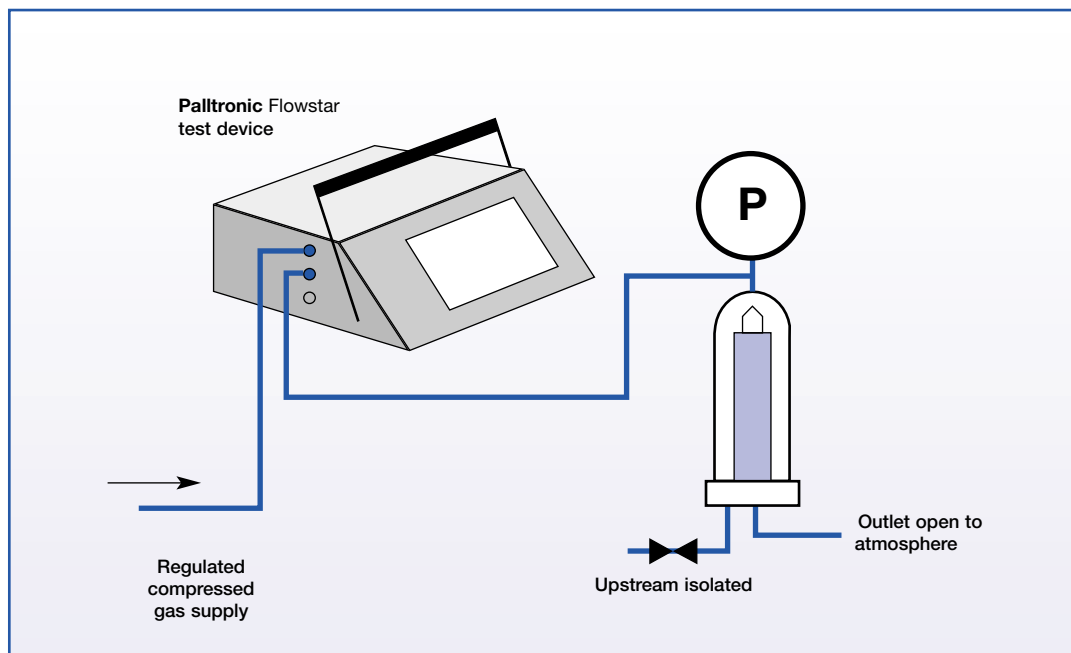

The Water Intrusion Integrity Test

The water intrusion test is performed on a dry filter. The upstream side of the filter assembly is filled with water and a pre-determined gas pressure is applied. The resulting water flow through the membrane can be measured directly on the upstream side using sensitive direct flow measurement equipment such as the **Palltronic** Flowstar or **Palltronic** Aquawit filter integrity test devices (as shown in Figure 11-2).

Figure II-2 The Water Intrusion Test

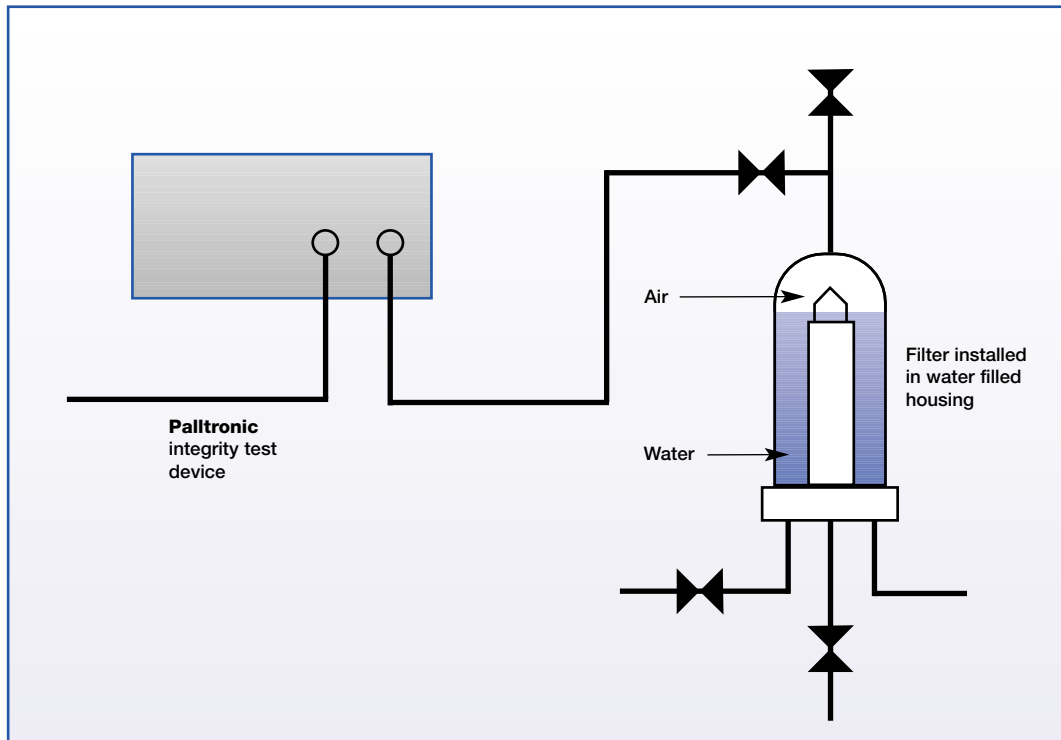

The aims of this series of tests were to:

- Determine the microbial removal efficiency of Emflon PFR filters in liquid challenge tests using *Brevundimonas diminuta* (ATCC 19146)
- Correlate non-destructive Forward Flow and water intrusion integrity tests with destructive challenge tests
- Determine integrity test parameters

1.2 Summary of Methods

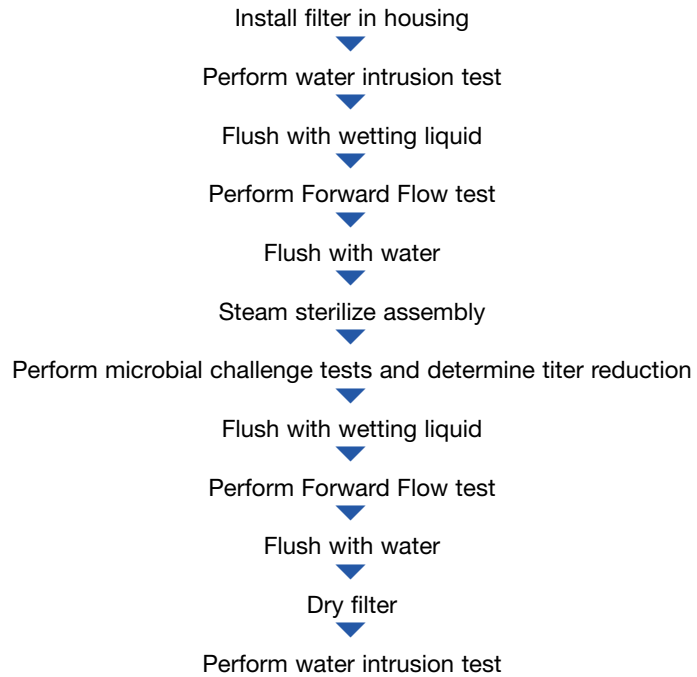

Emflon PFR filters (part number AB1PFR7PVH4) with a range of Forward Flow and water intrusion values were selected from manufacturing lots and subjected to microbial challenge tests using an aqueous suspension of *Brevundimonas diminuta* (ATCC 19146).

The filter sample was installed in a housing and tested for integrity by the water intrusion and/or Forward Flow method, prior to being autoclaved at 121°C (250°F) for 60 minutes. The filter assembly was then aseptically connected to a pre-sterilized challenge apparatus, shown schematically in Figure II-3.

Figure II-3 Microbial Challenge Apparatus

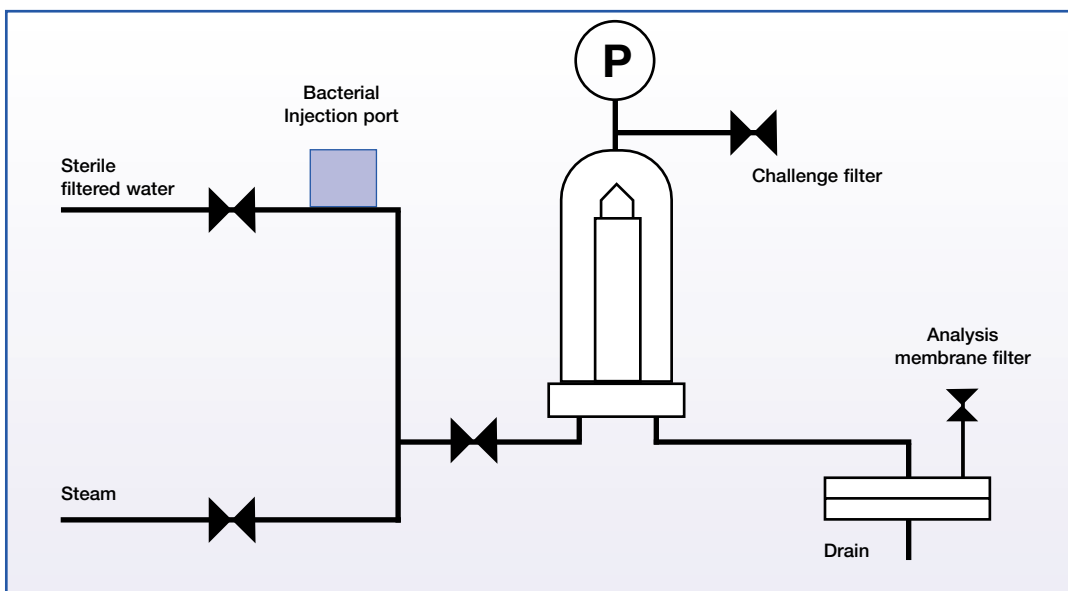

An aqueous suspension of *B. diminuta* was passed through the filter to achieve a challenge level of $> 1 \times 10^7$ colony forming units (CFU) per cm^2 of effective filtration area. A total challenge per filter of $> 1 \times 10^{11}$ CFU was achieved in all tests. On completion of the challenge, a second water intrusion and/or Forward Flow test was performed.

During the challenge test, the entire filter effluent was passed through a $0.2 \mu\text{m}$ -rated analysis disc on the downstream side of the test filter assembly. The filter disc was incubated on agar and, following incubation, the disc was examined to determine if bacteria had passed through the test filter during the challenge. The titer reduction (T_R) for each filter was determined as follows:

$$T_R = \frac{\text{Total number of organisms influent to the filter}}{\text{Number of colonies recorded on the downstream analysis disc}}$$

When no colonies were detected downstream, the titer reduction was expressed as:

$$>\text{Total number of organisms influent to the filter (e.g. } > 1 \times 10^{11}\text{)}$$

Please contact Pall if a more detailed description of the test methods is required.

1.3 Results

Forward Flow Correlation

The Forward Flow and *B. diminuta* retention results are shown in Table II-1, and presented graphically in Figure II-4. The higher of the two Forward Flow values are presented and the data are arranged in order of increasing Forward Flow value.

It was found that all of the 27 filters with Forward Flow values ≤ 5.7 mL/min gave sterile effluent when challenged with $> 1 \times 10^{11}$ CFU of *B. diminuta* per filter. Of the four filters with Forward Flow values between 7.0 and 36.0 mL/min one gave sterile effluent and the remaining three gave titer reductions between 1×10^5 and 1.51×10^6 .

Table II-1 Correlation of Forward Flow with *B. diminuta* Retention for Emflon PFR Filters (Part Number AB1PFR7PVH4)

Filter Serial Number	Forward Flow* (mL/min)	Sterile Effluent	Titer Reduction
PILF309054	3.3	Yes	$> 1.69 \times 10^{11}$
PILF309016	3.3	Yes	$> 1.69 \times 10^{11}$
PILF309029	3.3	Yes	$> 1.69 \times 10^{11}$
IA1516018	3.4	Yes	$> 1.10 \times 10^{11}$
PILF309001	3.4	Yes	$> 1.33 \times 10^{11}$
PILF309026	3.5	Yes	$> 1.69 \times 10^{11}$
PILF309022	3.5	Yes	$> 1.33 \times 10^{11}$
PILF309056	3.5	Yes	$> 1.93 \times 10^{11}$
PILF309052	3.6	Yes	$> 1.69 \times 10^{11}$
IA1516067	3.6	Yes	$> 1.10 \times 10^{11}$
PILF309018	3.6	Yes	$> 1.93 \times 10^{11}$
IA1516006	3.6	Yes	$> 1.10 \times 10^{11}$
PILF309015	3.6	Yes	$> 1.93 \times 10^{11}$
PILF309053	3.7	Yes	$> 1.93 \times 10^{11}$
PILF309021	3.7	Yes	$> 1.33 \times 10^{11}$
PILF309030	3.8	Yes	$> 1.33 \times 10^{11}$
PILF309028	3.8	Yes	$> 1.33 \times 10^{11}$
IA1516052	3.8	Yes	$> 1.10 \times 10^{11}$
PILF309050	3.9	Yes	$> 1.33 \times 10^{11}$
PILF309055	3.9	Yes	$> 1.69 \times 10^{11}$
PILF309006	4.0	Yes	$> 1.93 \times 10^{11}$
PILF309002	4.1	Yes	$> 1.44 \times 10^{11}$
PILF296002	4.1	Yes	$> 1.44 \times 10^{11}$

Table II-1 (Continued)

Filter Serial Number	Forward Flow* (mL/min)	Sterile Effluent	Titer Reduction
PILF309013	4.5	Yes	$> 1.93 \times 10^{11}$
PILF296035	4.7	Yes	$> 1.44 \times 10^{11}$
IA1516015	5.7	Yes	$> 1.10 \times 10^{11}$
PILF309003	5.7	Yes	$> 1.44 \times 10^{11}$
IA1516002	7.0	No	1×10^5
IA2417003	7.5	No	1×10^5
PILF296012	10.0	Yes	$> 1.51 \times 10^{11}$
PILF296013	36.0	No	1.51×10^6

* Forward Flow values at 1100 mbar (16 psi) air test pressure, wet with 25% (v/v) tertiary butyl alcohol in water.

Figure II-4 Correlation of Forward Flow with *B. diminuta* Retention for Emflon PFR Filters (Part Number AB1PFR7PVH4)

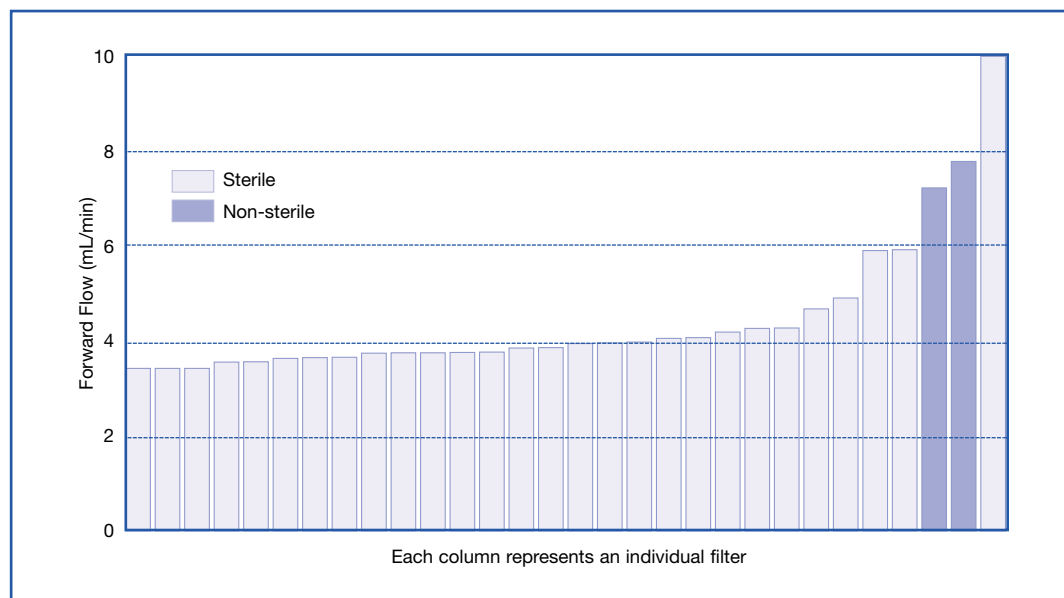

Water Intrusion Correlation

The water intrusion and bacterial retention results are shown in Table II-2, and presented graphically in Figure II-5. The higher of the two water intrusion values are presented and the data are arranged in order of increasing water intrusion value.

It was found that all 17 filters with water intrusion values ≤ 0.35 mL/min gave sterile effluent when challenged with $> 1 \times 10^{11}$ CFU of *B. diminuta* per filter. Of the nine filters with water intrusion values between 0.37 and 1.61 mL/min six gave sterile effluent and the remaining three gave titer reductions between 1×10^5 and 1.51×10^6 .

Table II-2 Correlation of Water Intrusion with *B. diminuta* Retention for Emflon PFR Filters (Part Number AB1PFR7PVH4)

Filter Serial Number	Water Intrusion* (mL/min)	Sterile Effluent	Titer Reduction
PILF309015	0.13	Yes	> 1.93 x 10 ¹¹
PILF309006	0.13	Yes	> 1.93 x 10 ¹¹
PILF309056	0.16	Yes	> 1.93 x 10 ¹¹
PILF309013	0.16	Yes	> 1.93 x 10 ¹¹
PILF309018	0.17	Yes	> 1.93 x 10 ¹¹
PILF309053	0.19	Yes	> 1.93 x 10 ¹¹
PILF309030	0.23	Yes	> 1.33 x 10 ¹¹
IA1516067	0.26	Yes	> 1.10 x 10 ¹¹
IA1516052	0.27	Yes	> 1.10 x 10 ¹¹
PILF309022	0.28	Yes	> 1.33 x 10 ¹¹
PILF309050	0.29	Yes	> 1.33 x 10 ¹¹
IA1516006	0.29	Yes	> 1.10 x 10 ¹¹
IA1516018	0.29	Yes	> 1.10 x 10 ¹¹
PILF309028	0.32	Yes	> 1.33 x 10 ¹¹
IA2417039	0.32	Yes	> 2.43 x 10 ¹¹
IA1516015	0.33	Yes	> 1.10 x 10 ¹¹
PILF309021	0.35	Yes	> 1.33 x 10 ¹¹
IA1516002	0.37	No	1 x 10 ⁵
IA2417125	0.37	Yes	> 2.43 x 10 ¹¹
IA2417045	0.37	Yes	> 2.43 x 10 ¹¹
IA2417102	0.38	Yes	> 2.43 x 10 ¹¹
IA2417054	0.39	Yes	> 2.43 x 10 ¹¹
PILF296012	0.46	Yes	> 1.51 x 10 ¹¹
IA2417003	0.48	No	1 x 10 ⁵
PILF309001	0.66	Yes	> 1.33 x 10 ¹¹
PILF296013	1.61	No	1.51 x 10 ⁶

* Water intrusion values at 2500 mbar (36 psig) air test pressure using deionized water

Figure II-5 Correlation of Water Intrusion with *B. diminuta* Retention for Emflon PFR Filters (Part Number AB1PFR7PVH4)

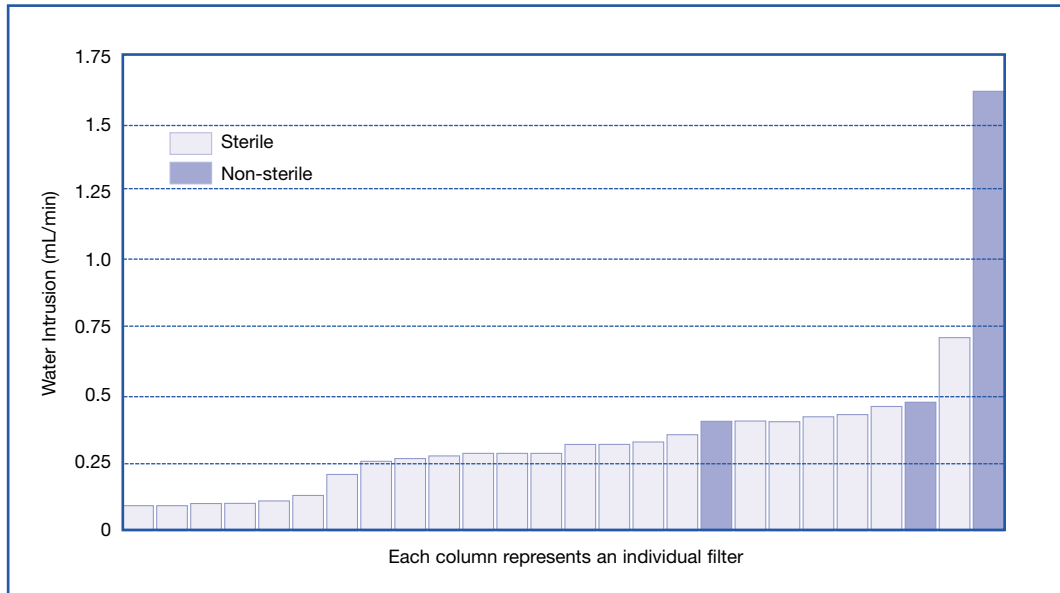

1.4 Conclusions

Based on the results of the validation study, both the Forward Flow and water intrusion test methods were demonstrated to be suitable non-destructive integrity tests for **Emflon** PFR filters. Integrity test parameters for **Emflon** PFR filters (part number AB1PFR7PVH4) were set as follows:

Forward Flow Integrity Test Parameters for AB1PFR7PVH4 Filters

Test pressure	1100 mbar (16 psi)
Wetting liquid	25% (v/v) tertiary butyl alcohol in water
Temperature	20°C (68°F) ± 5°C
Test gas	Air
Maximum allowable Forward Flow limit	5.5 mL/min

Water Intrusion Integrity Test Parameters for AB1PFR7PVH4 Filters

Test pressure	2500 mbar (36 psig)
Test liquid	Deionized water
Temperature	20°C (68°F) ± 2°C
Maximum allowable water intrusion limit	0.33 mL/min

These Forward Flow and water intrusion integrity test parameters:

- Incorporate a safety margin.
- Provide a high level of assurance of retention of *Brevundimonas diminuta* when challenged with $> 1 \times 10^7$ CFU/cm² of effective filtration area.
- Confirm that Emflon PFR filters satisfy the requirements of sterilizing grade filters as described in the FDA guidelines for aseptic processing (1987).

From these validation studies, Forward Flow test parameters were also set for 60% (v/v) isopropanol in water as a wetting fluid. These parameters were calculated based on the differences in the physical properties of the two test liquids. The test parameters for 60% (v/v) isopropanol in water are as follows:

Forward Flow Integrity Test Parameters for AB1PFR7PVH4 Filters

Test pressure	1040 mbar (15 psi)
Wetting liquid	60% (v/v) isopropanol in water
Temperature	20°C (68°F) ± 5°C
Test gas	Air
Maximum allowable Forward Flow limit	15 mL/min

Please note: Integrity test values are continually reviewed and monitored during routine production tests. Test values are issued and controlled by Pall Scientific and Laboratory Services. Please contact Pall for further details.

1.5 Microbial Validation of other Styles of Emflon PFR Filters

Based on the integrity test parameters set for 254 mm (10") Emflon PFR filters (Tables II-1 and II-2), Forward Flow and water intrusion integrity test parameters were set as follows for other smaller filter styles:

Forward Flow Integrity Test Parameters:

Filter Part Number	Wetting Liquid (20°C (68°F) ± 5°C)			
	25 % (v/v) Tertiary Butyl Alcohol in water		60% (v/v) Isopropyl Alcohol in Water	
	Air Test Pressure	Forward Flow Limit	Air Test Pressure	Forward Flow Limit
SBF1PFRP	1100 mbar (15.9 psi)	0.3 mL/min	1040 mbar (15 psi)	0.8 mL/min
MCY1110PFRP	1100 mbar (15.9 psi)	0.4 mL/min	1040 mbar (15 psi)	1.0 mL/min
MCY4440PFRP	1100 mbar (15.9 psi)	1.6 mL/min	1040 mbar (15 psi)	4.5 mL/min
MCY2230PFR	1100 mbar (15.9 psi)	1.0 mL/min	1040 mbar (15 psi)	2.7 mL/min
SLK7001PFRP	1100 mbar (15.9 psi)	1.0 mL/min	1040 mbar (15 psi)	2.7 mL/min
SLK7002PFRP	1100 mbar (15.9 psi)	2.0 mL/min	1040 mbar (15 psi)	5.5 mL/min
KA1PFRP	1100 mbar (15.9 psi)	0.3 mL/min	1040 mbar (15 psi)	0.8 mL/min
KA2PFRP	1100 mbar (15.9 psi)	0.6 mL/min	1040 mbar (15 psi)	1.7 mL/min
AB05PFR2PV	1100 mbar (15.9 psi)	2.7 mL/min	1040 mbar (15 psi)	7.8 mL/min

Water Intrusion Integrity Test Parameters:

Filter Part Number	Test Liquid Deionized Water (20°C (68°F) ± 5°C)	
	Air Test Pressure	Water Intrusion Limit
MCY4440PFRP	2500 mbar (36 psi)	0.10 mL/min
MCY2230PFR	2500 mbar (36 psi)	0.06 mL/min
SLK7001PFRP	2500 mbar (36 psi)	0.06 mL/min
SLK7002PFRP	2500 mbar (36 psi)	0.12 mL/min
AB05PFR2PV	2500 mbar (36 psi)	0.16 mL/min

In order to validate the integrity test limit values, production samples of these filter styles were subjected to bacterial challenge tests and Forward Flow and water intrusion integrity tests as described previously.

The bacterial challenge and Forward Flow results are shown in Table II-3 and the bacterial challenge and water intrusion results are shown in Table II-4. The Forward Flow and water intrusion results presented are the higher of the pre- and post-challenge measurements. All of the filters that were tested gave sterile filtrate when challenged.

Table II-3 Bacterial Challenge and Forward Flow Results using other Emflon PFR Filter Styles

Filter Part Number	Filter Serial Number	Forward Flow (mL/min)	Sterile Effluent	Titer Reduction
SBF1PFRPH4	ID3109068	0.25*	Yes	> 1.9 x 10 ¹⁰
	ID3109052	0.28*	Yes	> 1.9 x 10 ¹⁰
	ID3109046	0.32*	Yes	> 1.5 x 10 ¹⁰
	ID3109060	0.33*	Yes	> 1.9 x 10 ¹⁰
	ID3109019	0.40*	Yes	> 1.8 x 10 ¹⁰
	ID3109081	0.46*	Yes	> 1.6 x 10 ¹⁰
MCY1110PFRP	IC9677088	< 0.10*	Yes	> 1.9 x 10 ¹⁰
	IC9677049	0.2*	Yes	> 3.6 x 10 ¹⁰
	IC9677027	0.2*	Yes	> 3.4 x 10 ¹⁰
	IC9677028	0.2*	Yes	> 2.7 x 10 ¹⁰
	IC9677008	0.3*	Yes	> 2.5 x 10 ¹⁰
	IC9677012	0.4*	Yes	> 2.2 x 10 ¹⁰
MCY4440PFRPH4	IB5743035	2.2*	Yes	> 5.6 x 10 ¹⁰
	IB5743059	2.2*	Yes	> 5.6 x 10 ¹⁰
	IB5743016	2.2*	Yes	> 5.6 x 10 ¹⁰
	IB5743041	2.3*	Yes	> 5.6 x 10 ¹⁰
	IB5743013	2.3*	Yes	> 5.6 x 10 ¹⁰
	IB4024062	2.4*	Yes	> 1.2 x 10 ¹¹
	IB5743029	2.5*	Yes	> 5.6 x 10 ¹⁰
	IB4024091	2.7*	Yes	> 1.2 x 10 ¹¹
	IB4024058	2.7*	Yes	> 1.2 x 10 ¹¹
	IB4024097	2.8*	Yes	> 1.2 x 10 ¹¹
	IB4024099	2.8*	Yes	> 1.2 x 10 ¹¹
	IB4024015	2.9*	Yes	> 1.2 x 10 ¹¹

Table II-3 (Continued)

Filter Part Number	Filter Serial Number	Forward Flow (mL/min)	Sterile Effluent	Titer Reduction
MCY2230PFR	IB2473011	1.3*	Yes	> 2.7 x 10 ¹⁰
	IC0182019	1.3*	Yes	> 2.3 x 10 ¹⁰
	IB2473022	1.4*	Yes	> 3.8 x 10 ¹⁰
	IC0182016	1.4*	Yes	> 3.3 x 10 ¹⁰
	IC0182067	1.5*	Yes	> 1.5 x 10 ¹⁰
	IB2473051	1.5*	Yes	> 2.5 x 10 ¹⁰
	IB2473016	1.5*	Yes	> 3.0 x 10 ¹⁰
	IC0182024	1.6*	Yes	> 8.0 x 10 ¹⁰
	IB2473032	1.6*	Yes	> 2.6 x 10 ¹⁰
	IB2473059	1.7*	Yes	> 4.2 x 10 ¹⁰
	IC0182032	2.2*	Yes	> 2.5 x 10 ¹⁰
SLK7001PFRP	IC9879005	1.1*	Yes	> 3.4 x 10 ¹⁰
	IC9878017	1.1*	Yes	> 1.0 x 10 ¹¹
	IC9878075	1.1*	Yes	> 3.7 x 10 ¹⁰
	IC9878082	1.1*	Yes	> 3.7 x 10 ¹⁰
	IC9878087	1.1*	Yes	> 5.3 x 10 ¹⁰
	IC9878073	1.2*	Yes	> 1.0 x 10 ¹¹
SLK7002PFRP	IC0523076	3.1*	Yes	> 6.9 x 10 ¹⁰
	IC0523045	3.4*	Yes	> 8.7 x 10 ¹⁰
	IC0523094	3.4*	Yes	> 6.3 x 10 ¹⁰
	IC0523015	3.5*	Yes	> 5.5 x 10 ¹⁰
	IC0523042	3.5*	Yes	> 7.3 x 10 ¹⁰
	IC0523021	3.6*	Yes	> 7.4 x 10 ¹⁰

Table II-3 (Continued)

Filter Part Number	Filter Serial Number	Forward Flow (mL/min)	Sterile Effluent	Titer Reduction
KA1PFRP6	PB5410005	0.4*	Yes	> 1.3 x 10 ¹⁰
	PB5410056	0.4*	Yes	> 1.3 x 10 ¹⁰
	PB5410054	0.4*	Yes	> 3.6 x 10 ¹⁰
	IC7919048	0.5*	Yes	> 3.6 x 10 ¹⁰
	IC7919062	0.5*	Yes	> 3.0 x 10 ¹⁰
	PB5410034	0.5*	Yes	> 3.6 x 10 ¹⁰
	PB5410041	0.5*	Yes	> 4.3 x 10 ¹⁰
	PB5410046	0.5*	Yes	> 6.4 x 10 ⁹
	PB5410030	0.5*	Yes	> 1.6 x 10 ¹⁰
	PB5410023	0.5*	Yes	> 1.6 x 10 ¹⁰
	IC7919077	0.6*	Yes	> 3.0 x 10 ¹⁰
	PB5410028	0.6*	Yes	> 1.3 x 10 ¹⁰
	PB5410032	0.6*	Yes	> 1.8 x 10 ¹⁰
	PB5410051	0.6*	Yes	> 1.3 x 10 ¹⁰
	PB5410035	0.6*	Yes	> 4.3 x 10 ¹⁰
	IC7919079	0.7*	Yes	> 1.1 x 10 ¹⁰
	IC7919065	0.7*	Yes	> 1.1 x 10 ¹⁰
	IC7919003	0.7*	Yes	> 3.5 x 10 ¹⁰
KA2PFRP6	ID1884029	0.6*	Yes	> 5.3 x 10 ¹⁰
	ID1884048	0.6*	Yes	> 5.6 x 10 ¹⁰
	ID1884004	0.7*	Yes	> 6.2 x 10 ¹⁰
	ID1884010	0.7*	Yes	> 2.8 x 10 ¹⁰
	ID1884012	0.7*	Yes	> 2.2 x 10 ¹⁰
	ID1884016	0.7*	Yes	> 3.0 x 10 ¹⁰
	ID1884018	0.7*	Yes	> 4.0 x 10 ¹⁰
	ID1884019	0.7*	Yes	> 3.0 x 10 ¹⁰
	ID1884021	0.7*	Yes	> 2.3 x 10 ¹⁰
	ID1884041	0.7*	Yes	> 4.9 x 10 ¹⁰
	ID1884044	0.7*	Yes	> 2.7 x 10 ¹⁰
	ID1884023	0.8*	Yes	> 2.5 x 10 ¹⁰

Table II-3 (Continued)

Filter Part Number	Filter Serial Number	Forward Flow (mL/min)	Sterile Effluent	Titer Reduction
KA2PFRP6	ID1884037	0.8*	Yes	> 3.5 x 10 ¹⁰
	ID1884038	0.8*	Yes	> 2.4 x 10 ¹⁰
	ID1884002	0.9*	Yes	> 2.2 x 10 ¹⁰
	ID1884033	0.9*	Yes	> 2.4 x 10 ¹⁰
	ID1884049	0.9*	Yes	> 2.4 x 10 ¹⁰
	ID1884057	0.9*	Yes	> 2.6 x 10 ¹⁰
AB05PFR2PVH4	IA8508039	1.2*	Yes	> 8.0 x 10 ¹⁰
	IA9508010	1.3**	Yes	> 8.0 x 10 ¹⁰
	IA8508023	1.4**	Yes	> 8.0 x 10 ¹⁰
	IA8508008	1.8**	Yes	> 8.0 x 10 ¹⁰
	IA8508007	2.0**	Yes	> 8.0 x 10 ¹⁰
	IA8508002	40.0**	Yes	> 8.0 x 10 ¹⁰

* Forward Flow values at 1040 mbar (15 psi) air test pressure, wet with 60% (v/v) isopropyl alcohol in water

** Forward Flow values at 1100 mbar (16 psi) air test pressure, wet with 25% (v/v) tertiary butyl alcohol in water

**Table II-4 Bacterial Challenge and Water Intrusion
Results using Other Emflon PFR Filter Styles**

Filter Part Number	Filter Serial Number	Water Intrusion (mL/min)	Sterile Effluent	Titer Reduction
MCY4440PFRPH4	IB4024062	0.06	Yes	> 1.2 x 10 ¹¹
	IB4024091	0.07	Yes	> 1.2 x 10 ¹¹
	IB4024058	0.07	Yes	> 1.2 x 10 ¹¹
	IB5743035	0.07	Yes	> 5.6 x 10 ¹⁰
	IB5743013	0.07	Yes	> 5.6 x 10 ¹⁰
	IB5743041	0.08	Yes	> 5.6 x 10 ¹⁰
	IB5743059	0.08	Yes	> 5.6 x 10 ¹⁰
	IB5743029	0.08	Yes	> 5.6 x 10 ¹⁰
	IB4024097	0.08	Yes	> 1.2 x 10 ¹¹
	IB4024099	0.09	Yes	> 1.2 x 10 ¹¹
	IB4024015	0.09	Yes	> 1.2 x 10 ¹¹
	IB5743016	0.09	Yes	> 5.6 x 10 ¹⁰
	MCY2230PFR	IB2473022	0.02	Yes
IB2473016		0.03	Yes	> 3.0 x 10 ¹⁰
IB2473011		0.04	Yes	> 2.7 x 10 ¹⁰
IB2473051		0.04	Yes	> 2.5 x 10 ¹⁰
IB2473059		0.04	Yes	> 4.2 x 10 ¹⁰
IC0182019		0.04	Yes	> 2.3 x 10 ¹⁰
IC0182067		0.04	Yes	> 1.5 x 10 ¹⁰
IC0182016		0.04	Yes	> 3.3 x 10 ¹⁰
IB2473032		0.05	Yes	> 2.6 x 10 ¹⁰
IC0182032		0.05	Yes	> 2.5 x 10 ¹⁰
IC0182024		0.07	Yes	> 8.0 x 10 ¹⁰
SLK7001PFRP		IC9879005	0.04	Yes
	IC9879082	0.05	Yes	> 6.1 x 10 ¹⁰
	IC9879075	0.05	Yes	> 3.7 x 10 ¹⁰
	IC9879017	0.05	Yes	> 1.0 x 10 ¹¹
	IC9879087	0.05	Yes	> 5.3 x 10 ¹⁰
	IC9879073	0.06	Yes	> 1.0 x 10 ¹¹

Table II-4 (Continued)

Filter Part Number	Filter Serial Number	Water Intrusion (mL/min)	Sterile Effluent	Titer Reduction
SLK7002PFRP	IC0523076	0.9	Yes	> 6.9 x 10 ¹⁰
	IC0523015	0.10	Yes	> 5.5 x 10 ¹⁰
	IC0523021	0.10	Yes	> 7.4 x 10 ¹⁰
	IC0523042	0.10	Yes	> 7.3 x 10 ¹⁰
	IC0523045	0.11	Yes	> 8.7 x 10 ¹⁰
	IC0523094	0.11	Yes	> 6.3 x 10 ¹⁰
KA2PFRP6	ID1884021	0.11	Yes	> 2.3 x 10 ¹⁰
	ID1884002	0.02	Yes	> 2.2 x 10 ¹⁰
	ID1884010	0.03	Yes	> 2.8 x 10 ¹⁰
	ID1884012	0.03	Yes	> 2.2 x 10 ¹⁰
	ID1884016	0.03	Yes	> 3.0 x 10 ¹⁰
	ID1884018	0.03	Yes	> 4.0 x 10 ¹⁰
	ID1884023	0.03	Yes	> 2.5 x 10 ¹⁰
	ID1884029	0.03	Yes	> 5.3 x 10 ¹⁰
	ID1884037	0.03	Yes	> 3.5 x 10 ¹⁰
	ID1884044	0.03	Yes	> 2.7 x 10 ¹⁰
	ID1884048	0.03	Yes	> 5.6 x 10 ¹⁰
	ID1884049	0.03	Yes	> 2.4 x 10 ¹⁰
	ID1884004	0.04	Yes	> 6.2 x 10 ¹⁰
	ID1884019	0.04	Yes	> 3.3 x 10 ¹⁰
	ID1884033	0.04	Yes	> 2.4 x 10 ¹⁰
	ID1884038	0.04	Yes	> 2.1 x 10 ¹⁰
ID1884041	0.04	Yes	> 4.9 x 10 ¹⁰	
ID1884057	0.04	Yes	> 2.6 x 10 ¹⁰	
AB05PFR2PVH4	IA8508007	0.12	Yes	> 8.0 x 10 ¹⁰
	IA9508008	0.12	Yes	> 8.0 x 10 ¹⁰
	IA8508010	0.12	Yes	> 8.0 x 10 ¹⁰
	IA8508023	0.15	Yes	> 8.0 x 10 ¹⁰
	IA8508039	0.15	Yes	> 8.0 x 10 ¹⁰
	IA8508002	1.59	Yes	> 8.0 x 10 ¹⁰

* Water intrusion values at 2500 mbar (36 psig) air test pressure using deionized water

2. Aerosol Bacterial Retention Tests using *Brevundimonas diminuta*

2.1 Introduction

The aim of these tests was to demonstrate the bacterial retention capability of **Emflon** PFR filters using *Brevundimonas diminuta* (ATCC 19146) in aerosol challenge tests carried out in both the forward ('out-to-in') and reverse ('in-to-out') directions of flow.

2.2 Summary of Methods

Emflon PFR filters (part number AB1PFR7PVH4) from standard production lots were used for the tests. Before and after the challenge tests, filter integrity was confirmed using the Forward Flow test method. Prior to the challenge test, residual wetting liquid was removed from the filter by oven drying at 50°C (122°F) overnight.

In order to perform the challenge, the test filter was installed in a stainless steel housing and then the assembly was sterilized by autoclave and aseptically connected to the sterile challenge apparatus shown schematically in Figure II-6. A nebulized suspension of *Brevundimonas diminuta* (ATCC 19146) was passed through the test filter at a flow rate of 28 L/min for 15 minutes duration. A liquid impingement sampler downstream of the test assembly ensured recovery of any bacteria penetrating the filter. Filters were initially challenged in the reverse flow direction and then in the forward flow direction.

Both the challenge suspension of bacteria and the recovery buffer were assayed to determine influent challenge and effluent recovery respectively. The titer reduction (T_R) for each filter was determined as follows:

$$T_R = \frac{\text{Number of bacteria in the challenge suspension} \times \text{apparatus efficiency}^*}{\text{Number of bacteria assayed in the recovery buffer}}$$

[* Apparatus efficiency was determined by running the challenge with no filter installed and assaying the bacterial count in the downstream impinger.]

When no colonies were detected downstream of the filter, the titer reduction was expressed as:

$$> \text{total number of organisms influent to the filter (e.g. } > 1 \times 10^9 \text{)}$$

Please contact Pall if a more detailed description of the test method is required.

Figure II-6 Schematic Diagram of Aerosol Challenge Apparatus

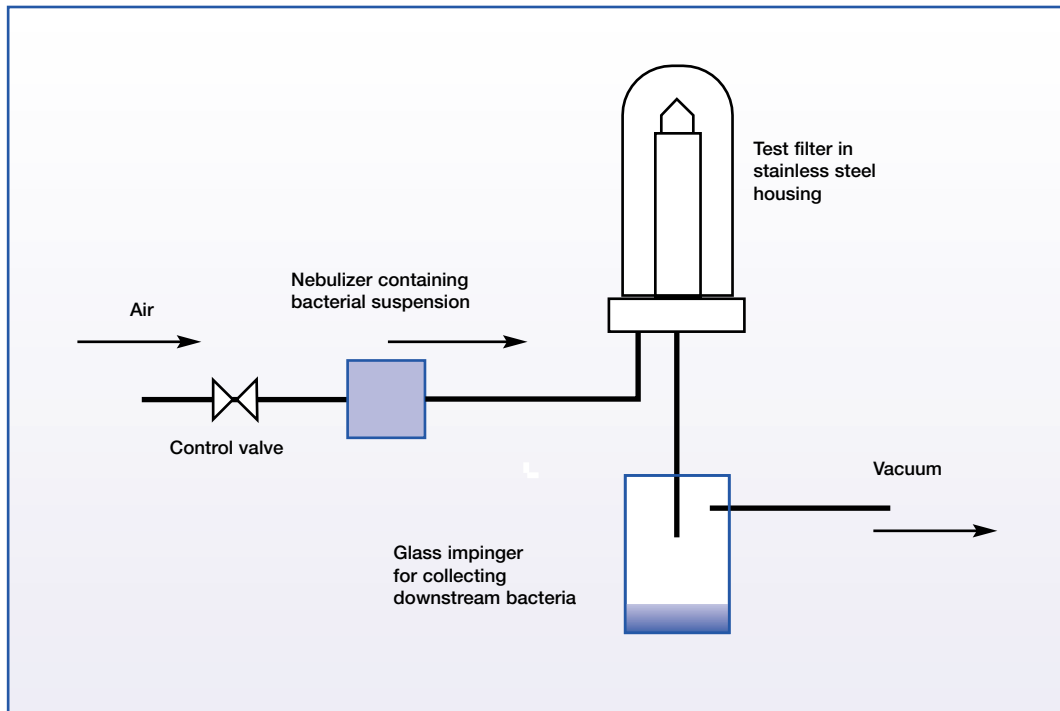

2.3 Results

The results of the challenge tests are shown in Tables II-5 and II-6. All of the filters tested retained aerosol *B. diminuta* challenges in both the forward ('out to in') and the reverse ('in to out') flow directions, at challenge levels between 3.1×10^8 and 5.9×10^9 CFU per 25cm (10inch) filter cartridges. The filters were all found to be integral prior to and after each challenge using the Forward Flow test method.

Table II-5 Aerosol Challenge Results in the Reverse ('in to out') Flow Direction

Filter Serial Number	Sterile Effluent	Titer Reduction
IB6076330	Yes	> 4.18 x 10 ⁸
IB6076333	Yes	> 8.42 x 10 ⁸
IB6076331	Yes	> 1.02 x 10 ⁹
IB6076338	Yes	> 6.80 x 10 ⁸
IB6076321	Yes	> 4.65 x 10 ⁸
IB6076340	Yes	> 3.10 x 10 ⁸

Table II-6 Aerosol Challenge Results in the Forward ('out to in') Flow Direction

Filter Serial Number	Sterile Effluent	Titer Reduction
IB6076330	Yes	> 3.66 x 10 ⁹
IB6076333	Yes	> 5.08 x 10 ⁹
IB6076331	Yes	> 5.94 x 10 ⁹
IB6076338	Yes	> 2.29 x 10 ⁹
IB6076321	Yes	> 4.44 x 10 ⁹
IB6076340	Yes	> 4.38 x 10 ⁹

2.4 Conclusions

These data confirm that standard production **Emflon** PFR filters will retain high levels of bacterial aerosols in both the forward and reverse directions, as demonstrated using *B. diminuta*.

3. Long-term Aerosol Microbial Challenge Tests

3.1 Introduction

The purpose of these tests was to perform extended aerosol challenge tests on **Emflon** PFR filters in order to simulate the conditions that a vent filter may be exposed to in a typical pharmaceutical application. This aerosol challenge test was conducted at intervals over a 30-day period using two challenge organisms; *Brevundimonas diminuta* (ATCC 19146) and *Bacillus subtilis* var niger spores (NCTC 10073).

The challenge tests were performed by the Centre for Applied Microbiology & Research (CAMR), Porton Down, Wiltshire, UK.

3.2 Summary of Methods

A **Pall** Novasip™ filter capsule incorporating **Emflon** PFR filter membrane was used for this study (Pall part number C3PFRP1, serial number ID21824411).

In order to simulate the repeated steam exposure that a filter could be subjected to in a multiple use vent application, the filter capsule was initially subjected to ten repeat one-hour steam cycles at 125°C (257°F). Following each steam cycle, the filter was cooled by flowing dry compressed air through the membrane for 30 minutes. After the ten steam cycles had been completed, the integrity of the filter capsule was confirmed by performing a water intrusion integrity test using a test pressure of 2500 mbar (36 psig). The filter capsule was then dried before being sent to CAMR for the long-term challenge tests to be performed.

Prior to being installed on the challenge rig, the filter was autoclaved at 126°C (259°F) for 11 minutes and, after cooling, the upstream side of the assembly was rinsed with pyrogen-free water. The rinse with water was performed in order to simulate the upstream moisture level that would typically be observed immediately after a water intrusion test has been performed. The filter was then connected to the sterile Henderson aerosol challenge apparatus shown schematically in Figure II-7.

All connections downstream of the filter had been autoclaved and dried prior to the filter being installed in the apparatus. Humidified air (relative humidity > 90%) was passed through the filter at a flow rate of 60 liters per minute for 8 hours each working day (Monday to Friday). The flow of air was controlled by the critical orifice installed in the apparatus.

Aqueous suspensions of *B. diminuta* and spores of *B. subtilis* were prepared using standard microbiological techniques. Two Collison nebulizers were attached to the rig so that water and one of the challenge organisms could be nebulized alternatively. The contents of the Collison sprays were nebulized into a stainless steel spray tube that was of sufficient size to allow mixing and conditioning of the aerosols generated in the clean filtered humidified air. Microbial challenge tests were performed on each working day over a 30-day period. As no challenges were performed at weekends, a total of 22 daily challenges were performed with each micro-organism.

During the challenge periods, and at intervals during the remainder of the day, the air on the downstream side of the filter was sampled using an impinger. The clamps fitted on the flexible tubing downstream of the filter assembly were adjusted to sample the air flow as required. When downstream air samples were not being taken the air was directed so that the impinger was bypassed.

Over the course of the 30-day period contaminated liquid built up on the upstream side of the filter assembly. In order to maintain the flow of air through the filter membrane, this fluid (20 - 30mL) was removed via the drain valve on a weekly basis.

Figure II-7 Henderson Apparatus for Long Term Microbial Challenge Testing a Novasip Filter (Pall Part Number C3PFRP1)

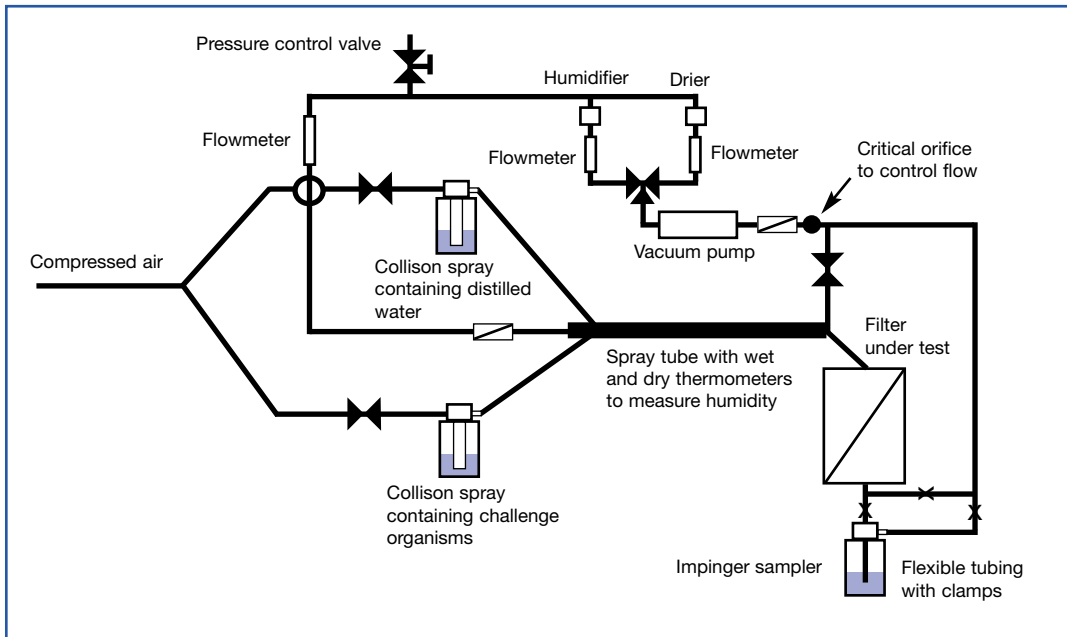

Typically the daily challenge tests (performed Monday to Friday) were carried out according to the following schedule:

- 08:15 Flow of humidified air passing through the filter under test initiated
- 10:00 Filter challenged with a suspension of aerosolized spores of *Bacillus subtilis*.
Air downstream of the filter sampled throughout duration of the challenge period.
- 10:30 Filter challenged with aerosolized suspension of *Brevundimonas diminuta*.
Air downstream of the filter sampled throughout duration of the challenge period.
- 11:00 Air downstream of the filter sampled for 30 minutes.
- 13.30 Air downstream of the filter sampled for 30 minutes.
- 15.30 Air downstream of the filter sampled for 30 minutes.
- 16:15 Air supply turned off and downstream side of filter closed with a sterile cap.

The fluid in the collection impingers was analyzed for the challenge organisms using standard microbiological techniques and the challenge levels were determined by assaying the fluid in the impinger after a known weight of challenge suspension had been aerosolized without the test filter in place.

Please contact Pall if further details about the test methods are required.

3.3 Results

The daily aerosol challenge levels of *B. diminuta* and spores of *B. subtilis* are shown in Table II-7. The total challenge levels over the 30 day period were 6.8×10^{10} for *B. diminuta* and 2.6×10^{10} for spores of *B. subtilis*. These challenge levels are equivalent to $> 1 \times 10^7$ Colony Forming Units (CFU) per cm^2 of filter membrane for each organism.

Air on the downstream side of the filter was sampled during the actual challenge periods and also at intervals throughout the remainder of the day. The purpose of this sampling regime was to determine if organisms would penetrate through the filter both at the time of the challenge and also whether they could penetrate through the filter over an extended time. No bacteria were detected in any of the five downstream air samples taken on each working day. All the samples collected were sterile.

Table II-7 Daily Challenge Levels and Recoveries of *Brevundimonas diminuta* and Spores of *Bacillus subtilis*

Day	<i>B. diminuta</i> Challenge (cfu)	Recovery (cfu)	<i>B. subtilis</i> Challenge (cfu)	Recovery (cfu)
1	5.74×10^9	0	1.15×10^9	0
2	5.79×10^9	0	1.05×10^9	0
3	2.57×10^9	0	1.01×10^9	0
4	2.94×10^9	0	1.64×10^9	0
7	6.42×10^9	0	1.21×10^9	0
8	2.75×10^9	0	1.14×10^9	0
9	2.79×10^9	0	1.13×10^9	0
10	2.73×10^9	0	1.17×10^9	0
11	2.72×10^9	0	1.49×10^9	0
14	2.74×10^9	0	1.15×10^9	0
15	2.73×10^9	0	1.27×10^9	0
16	3.16×10^9	0	1.07×10^9	0
17	2.55×10^9	0	1.06×10^9	0
18	2.42×10^9	0	1.38×10^9	0
21	2.54×10^9	0	1.08×10^9	0
22	2.60×10^9	0	1.12×10^9	0
23	2.68×10^9	0	1.13×10^9	0
24	2.65×10^9	0	1.18×10^9	0
25	2.68×10^9	0	1.39×10^9	0
28	2.60×10^9	0	1.10×10^9	0
29	2.23×10^9	0	0.98×10^9	0
30	2.27×10^9	0	1.30×10^9	0

Sum of applied organisms 6.6×10^{10} and 2.6×10^{10}

3.4 Conclusions

Emflon PFR filters give sterile effluent when challenged with aerosol suspensions of *B. diminuta* and *B. subtilis* var niger spores over extended periods of time. The conditions used during this study were designed to simulate conditions that could typically be experienced in a pharmaceutical vent application.

Sterility was achieved after 30 days under the following conditions:

- Filter initially stressed by exposure to ten steam cycles
- No heat jacket or insulation used on the filter assembly
- High humidity air
- Presence of water on the upstream side of the filter
- High flow and zero flow conditions
- Challenge with bacterial spores
- Challenge with diminutive bacteria
- No filter re-sterilization over the 30-day period

4. Bacteriophage and Spore Aerosol Challenge Tests

4.1 Introduction

The aims of this study were to determine the typical removal efficiencies of **Emflon** PFR filters with the following challenge organisms:

- PP7 bacteriophage, 25 nm in diameter
- MS-2 coliphage, 23 nm in diameter
- *Bacillus subtilis* var niger spores, typically 1.0 µm by 0.7 µm

The challenge tests were performed by the Centre for Applied Microbiology & Research (CAMR), Porton Down, Wiltshire, UK.

4.2 Summary of Methods

Emflon PFR filters (part number AB1PFR7PVH4) from standard production lots were used for the tests. Before and after the challenge tests, filter integrity was confirmed using the Forward Flow test method. Before the challenge test was performed, residual wetting liquid was removed from the filter by oven drying at 50°C (122°F) overnight.

Prior to each challenge sequence the components of the challenge rig were autoclaved and then aseptically connected, as shown in Figure II-8.

The challenge suspensions were placed in the Collison sprays and placed in the chamber. The suspensions were nebulized by applying compressed air. The relative humidity of the air flowing through the system was checked before and after the challenge step by a relative humidity meter. The flow rate through the system was measured and the tests were performed at an air flow rate of 700 ± 20 L/min.

A cyclone sampler was used to collect the organisms generated in the system. Sterile collecting fluid was fed into the cyclone sampler and particles in the air stream were deposited by centrifugal force into the swirling liquid on the wall of the device. On completion of the challenge, the volume of collection fluid was measured and then assayed for the challenge organism using an appropriate technique.

Background levels were measured by operating the system with a filter in place and with the Collison sprays switched 'off', and challenge levels were determined by operating the system with the filters removed and the Collison sprays switched 'on'.

The titer reduction (T_R) for each filter was determined as follows:

$$T_R^* = \frac{\text{Number of bacteria in the challenge}}{\text{Number of bacteria assayed in the recovery buffer}}$$

* Calculation of the titer reduction takes into account the volume of collecting fluid assayed for phage

When no colonies were detected downstream, the titer reduction was expressed as:

> total number of organisms influent to the filter (e.g. > 1 x 10¹⁰)

Please contact Pall if a more detailed description of the test method is required.

Figure II-8 Schematic Diagram of Challenge Apparatus

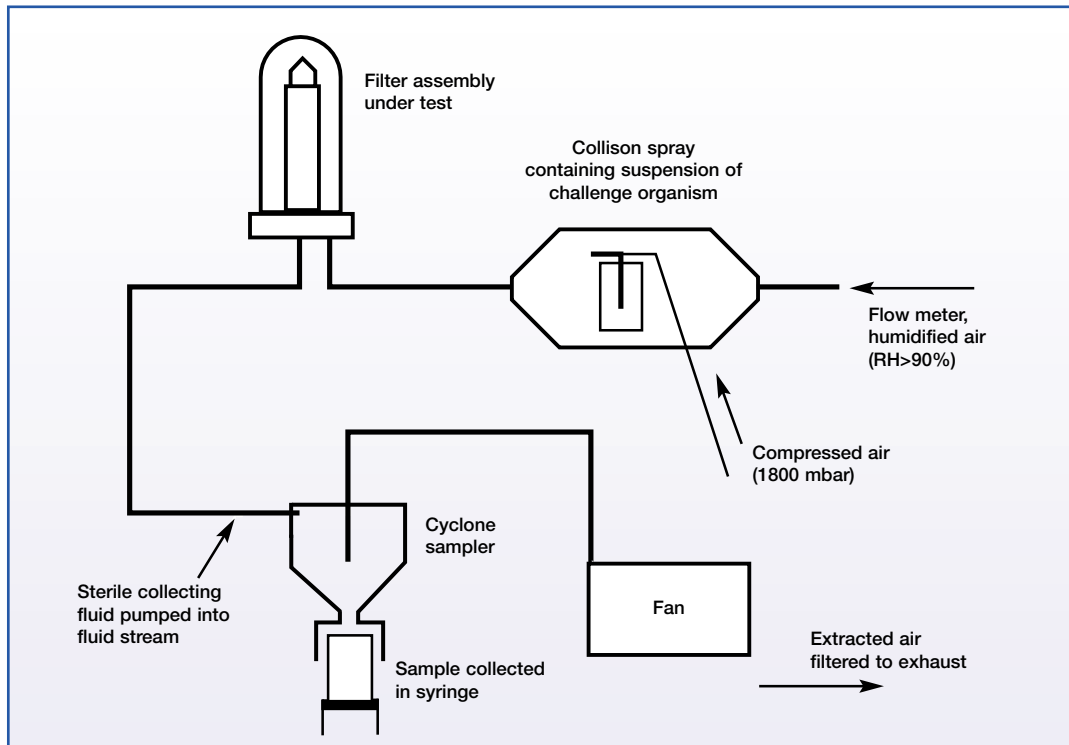

4.3 Results

Six standard production **Emflon** PFR filters (part number AB1PFR7PVH4) were tested with each of the challenge organisms and the results are presented in Tables II-8, II-9 and II-10.

The challenge tests were performed at high flow rates (700 ± 20 L/min) and high relative humidity (90%). The challenge levels used for the PP7 and MS-2 challenges represented $>10^7$ particles per cm^2 of effective filter area. Due to the larger size of *B. subtilis* the highest challenge level that could be achieved in these tests was in the order of 10^6 per cm^2 of effective filter area.

In all cases, the titer reductions obtained were very high. For the phages PP7 and MS-2 the titer reductions obtained were $\geq 10^{11}$ and with *B. subtilis* the titer reductions were $\geq 10^{10}$.

Table II-8 Aerosol Challenge Results for Bacteriophage PP7

Filter Serial Number	Forward Flow* (mL/min)	Sterile Effluent	Titer Reduction
IB1729540	9.5	Yes	$> 2.4 \times 10^{11}$
IB1981325	9.0	Yes	$> 2.5 \times 10^{11}$
IB1981528	9.5	Yes	$> 2.8 \times 10^{11}$
IB3991133	10.0	Yes	$> 2.9 \times 10^{11}$
IB1729541	9.2	No**	2.5×10^{11}
IB3991057	9.5	Yes	$> 2.5 \times 10^{11}$

* Forward Flow values at 1040 mbar (15 psi) air test pressure, wet with 60% (v/v) isopropyl alcohol in water, maximum allowable flow 15 mL/min

** One plaque forming unit recovered on the downstream side.

Table II-9 Aerosol Challenge Results for Bacteriophage MS-2

Filter Serial Number	Forward Flow* (mL/min)	Sterile Effluent	Titer Reduction
IA9955089	10.0	Yes	> 1.6 x 10 ¹¹
IA9955061	10.0	Yes	> 2.7 x 10 ¹¹
IA9955189	10.0	Yes	> 1.4 x 10 ¹¹
IA7179046	12.0	Yes	> 1.7 x 10 ¹¹
IA8442125	8.9	Yes	> 1.4 x 10 ¹¹
IA9846177	9.6	Yes	> 1.4 x 10 ¹¹

* Forward Flow values at 1040 mbar (15 psi) air test pressure, wet with 60% (v/v) isopropyl alcohol in water, maximum allowable flow 15 mL/min

Table II-10 Aerosol Challenge Results using *Bacillus subtilis* Spores

Filter Serial Number	Forward Flow* (mL/min)	Sterile Effluent	Titer Reduction
IA9955089	10.0	Yes	> 2.3 x 10 ¹⁰
IA9955061	10.0	Yes	> 2.3 x 10 ¹⁰
IA9955189	10.0	Yes	> 2.3 x 10 ¹⁰
IA7179046	12.0	Yes	> 2.3 x 10 ¹⁰
IA8442125	8.9	Yes	> 2.3 x 10 ¹⁰
IA9846177	9.6	Yes	> 2.3 x 10 ¹⁰

* Forward Flow values at 1040 mbar (15 psi) air test pressure, wet with 60% (v/v) isopropyl alcohol in water, maximum allowable flow 15 mL/min

4.4 Conclusions

The data presented confirm that standard production **Emflon** PFR filters will retain very high challenge levels of aerosolized phage, as demonstrated using PP7 and MS-2 phages, and aerosols of non-vegetative spores, as demonstrated using spores of *B. subtilis*.

5. Sodium Chloride Aerosol Challenge Testing

5.1 Introduction

The aim of this study was to perform aerosol challenge tests with sodium chloride in order to define the particulate removal efficiency and assign a rating for **Emflon** PFR filters in gases.

5.2 Summary of Methods

Typical production **Emflon** PFR filters (part number AB1PFR7PVH4) were used in these tests.

The sodium chloride challenge tests were performed using the apparatus shown schematically in Figure II-9. Before use, the pipe work downstream of the filter assembly was removed from the rig, flushed with filtered deionized water, and dried with compressed air filtered to 0.003 µm. The test filter was installed in the rig and filtered compressed air was passed through the system at a flow rate of approximately 132.5 L/min.

A Condensation Nucleus Counter (CNC) was used to count particles in the air on the downstream side of the filter assembly, at a sample flow rate of 1.5 L/min. The counter provided a count of all particles ≥ 0.003 µm in diameter.

Once the system had stabilized, and only occasional background counts were obtained, the filter was challenged with an aerosol of sodium chloride particles. The aerosol was generated from a 0.04% (w/v) solution of sodium chloride using an atomizer to produce a cloud of sodium chloride aerosols. The challenge was passed through the filters and the air on the downstream side of the filter (flow rate 1.5 L/min) was passed through the CNC for a minimum of 75 minutes.

The challenge level of sodium chloride aerosols was determined by running the system without a filter in place.

Particle reduction up to 132.5 L/min was calculated as follows:

$$\text{Particle reduction} = \frac{\text{Upstream counts per unit volume}}{\text{Downstream counts per unit volume}}$$

Where no particles were detected on the downstream side, the particle reduction was expressed as > total number of particles influent to the filter.

Please contact Pall if further details about the test methods are required.

Figure II-9 Schematic Diagram of Test Apparatus

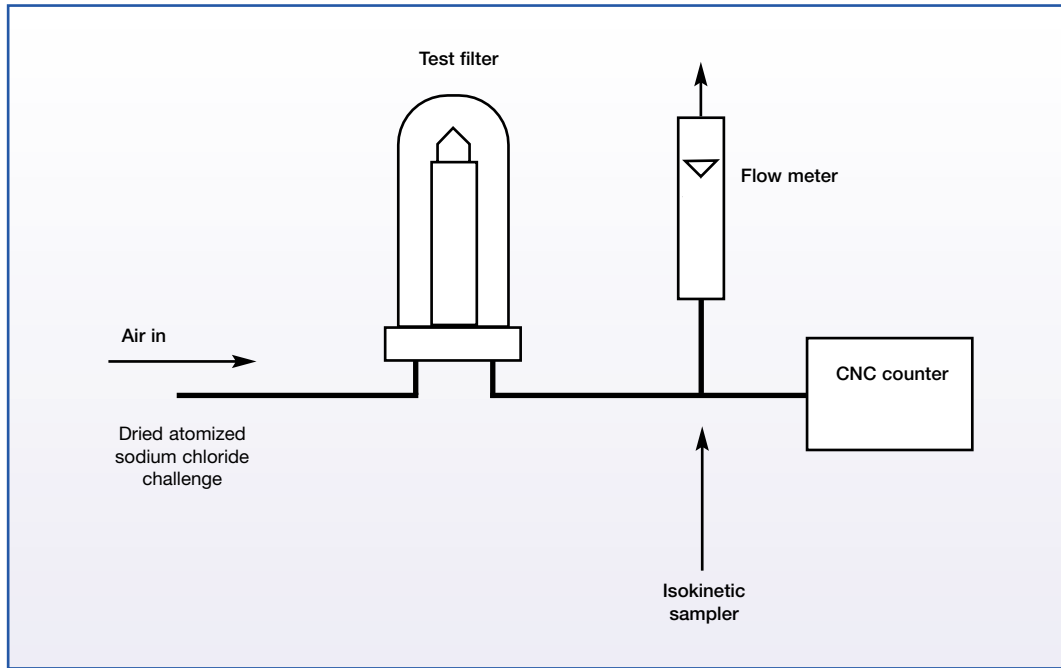

5.3 Results

The sodium chloride aerosol challenge results are shown in Table II-11.

Table II-11 Sodium Chloride Challenge Results

Filter Serial Number	Upstream Counts (Per Liter)	Downstream Counts (Per Liter)	Particle Reduction up to 132.5 L/min
IA2417119	6.9×10^7	0	$> 6.9 \times 10^7$
IA2417028	7.5×10^7	2.2	3.4×10^7
IA2417015	6.8×10^7	1.8	3.8×10^7
IA2348011	6.3×10^7	1.5	4.2×10^7
IA2348032	5.4×10^7	0.4	1.4×10^8

All of the filters tested demonstrated high removal efficiencies with sodium chloride particles. In all cases the particle reduction at 132.5 L/min was $>10^7$.

5.4 Conclusions

The data presented support a rating of $0.003 \mu\text{m}$ for **Emflon** PFR filters when aerosol challenge tested with sodium chloride at 132.5 L/min.

Part III. Validation of Physical Characteristics

1. Resistance to Steam Sterilization

1.1 Introduction

The aim of these tests was to determine the effects of steam in place sterilization on the integrity of **Emflon** PFR filters.

1.2 Summary of Methods

The procedure for these tests was based on the recommended instructions for steam sterilization described in Pall publication USD805 ‘Steam Sterilization of Pall Filter Assemblies which Utilize Replaceable Filter Cartridges’.

During the tests, typical production filters (part number AB1PFR7PVH4) installed in a stainless steel housing were steamed in place using saturated condensate-free steam in a test set-up shown schematically in Figure III-1.

In each series of tests the following was performed:

- Steam pressure and flow were held constant during the sterilization period
- After each steam in place cycle the filters were cooled by passing dry compressed air through the test filter
- Test filter cartridges were Forward Flow integrity tested at appropriate intervals

Tests were performed under the conditions shown in Table III-1.

Table III-1 Steam Sterilization Test Conditions

Test	Temperature	Steam Flow Direction	Cycle Time	Differential Pressure	Total Steam Exposure
A	142°C (288°F)	Forward	11 hours	< 300 mbar (4.3 psid)	220 hours
B	142°C (288°F)	Forward	1 hour	< 300 mbar (4.3 psid)	165 hours
C	125°C (257°F)	Forward	1 hour	1000 mbar (14.5 psid)	30 hours
D	125°C (257°F)	Reverse	1 hour	500 mbar (7.2 psid)	40 hours

In order to achieve high initial differential pressures across the filters at the start of the steam cycles during test C, filters were wetted with 60% (v/v) isopropyl alcohol in water before being exposed to steam pressure. This resulted in a transient (approximately 5 minute) 1000 mbar (14.5 psid) differential pressure in the forward (‘out to in’) direction.

Please note: Water flushing to remove solvent mixtures is normally recommended before steaming.

Please contact Pall if further details about the test methods are required.

Figure III-1 Test Set-Up for Steam Sterilization in the Forward Direction

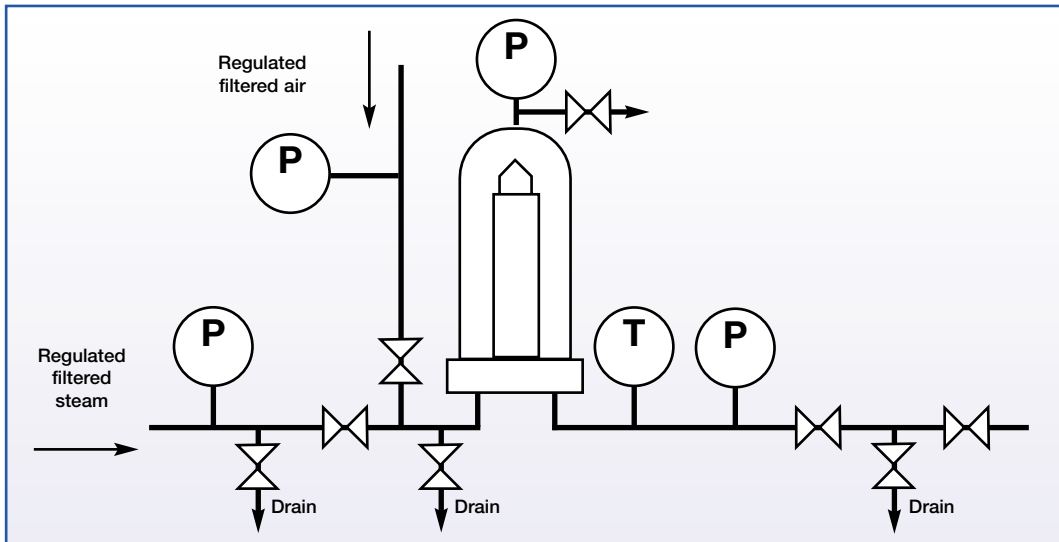

1.3 Results

1.3.1 Steam Sterilization Tests using Eleven Hour Cycles at 142°C (288°F) (Test A)

During this study, filters were steamed at 142°C (288°F) in eleven hour cycles in the forward ('out to in') direction. These tests were performed in order to determine the effects of cumulative steam exposure. The differential pressure during the tests was controlled and maintained at < 300 mbar (4.3 psid). At intervals, the filters were Forward Flow integrity tested. The data are shown in Table III-2.

After 176 hours exposure to steam, all filters passed the Forward Flow test and after 220 hours exposure two of the five filters passed.

Table III-2 Effect of 11 Hour Steam Cycles on Forward Flow Values (Test A)

Filter Serial Number	Forward Flow* (mL/min) after the following Number of Hours:					
	0	44	88	132	176	220
IA2417114	3.6	3.9	5.3	3.9	5.0	5.3
IA2417059	3.6	3.4	4.1	3.4	3.5	5.1
IA2417083	4.1	4.3	4.3	4.9	4.5	9.5
IA2417086	4.1	3.8	5.1	5.4	4.9	8.0
IA2417094	3.6	4.5	5.0	5.3	5.4	8.2

* Forward Flow values at 1100 mbar (16 psi) air test pressure, wet with 25% (v/v) tertiary butyl alcohol in water, limit value 5.5 mL/min

1.3.2 Steam Sterilization Tests using One Hour Cycles at 142°C (288°F) (Test B)

During this study, filters were steamed at 142°C (288°F) in one hour cycles in the forward ('out to in') direction. This protocol was designed to simulate the thermal cycling of steam sterilization under typical process conditions. The differential pressure during the tests was controlled and maintained at < 300 mbar (4.3 psid). After 165 one hour cycles the filters were Forward Flow integrity tested and all were found to pass. The results are shown in Table III-3.

Table III-3 Effect of 1 Hour Steam Cycles on Forward Flow Values (Test B)

Filter Serial Number	Initial Forward Flow* (mL/min)	Forward Flow* (mL/min) after 165 x 1 Hour Cycles
IA4294034	4.0	4.0
IA4294036	3.7	3.7
IA4294040	4.1	4.1
IA4294051	4.1	3.9
IA4294074	4.0	3.5

* Forward Flow values at 1100 mbar (16 psi) air test pressure, wet with 25% (v/v) tertiary butyl alcohol in water, limit value 5.5 mL/min

1.3.3 Steam Sterilization Tests using High Differential Pressures in the Forward Direction (Test C)

During this study, filters were steamed using high initial differential pressures (1000 mbar (14.5 psid)) at 125°C (257°F). The tests were performed in one hour cycles in the forward ('out to in') direction. These tests were performed in order to simulate steam conditions where transient high differential pressures (> 300 mbar (4.3 psid)) may occur during the steam sterilization cycle. At appropriate intervals, the filters were Forward Flow integrity tested and the results are shown in Table III-4.

All filters passed the Forward Flow integrity test after exposure to 30 one hour steam cycles.

Table III-4 Effect of High Initial Differential Pressures on Forward Flow Values

Filter Serial Number	Forward Flow* (mL/min) after the following Number of One Hour Steam Cycles:							
	0	1	2	4	8	16	24	30
PILF296004	3.2	4.1	3.0	3.6	4.1	4.0	5.0	5.1
PILF296014	3.5	3.5	3.1	3.6	3.8	3.6	3.6	4.6
PILF296016	3.5	3.6	3.4	3.5	3.6	3.7	3.8	4.5
PILF296022	3.3	3.5	3.1	3.4	3.0	3.5	3.7	3.0
PILF296032	3.4	3.6	3.4	3.8	3.9	3.9	3.9	3.0

* Forward Flow values at 1100 mbar (16 psi) air test pressure, wet with 25% (v/v) tertiary butyl alcohol in water, limit value 5.5 mL/min

1.3.4 Steam Sterilization Tests using High Differential Pressures in the Reverse Direction

During this study, filters were steamed using high reverse differential pressures (500 mbar (7.2 psid)) at 125°C (257°F). The tests were performed in one hour cycles in the reverse ('in to out') direction. These tests were performed in order to simulate conditions where reverse steam sterilization may be required or where reverse differential pressure may occur with transient high differential pressures (> 200 mbar). At appropriate intervals, the filters were Forward Flow integrity tested and the results are shown in Table III-5.

All filters passed the Forward Flow integrity test after exposure to 40 one hour steam cycles.

Table III-5 Effect of High Reverse Differential Pressures on Forward Flow Values

Filter Serial Number	Forward Flow* (mL/min) after the following Number of One Hour Steam Cycles in the Reverse Direction								
	0	5	10	15	20	25	30	35	40
IA2417032	2.8	3.1	2.9	3.0	3.3	3.4	3.5	3.4	3.4
IA2417051	2.9	2.8	2.4	2.6	2.9	2.8	2.7	2.6	2.7
IA2417031	3.6	3.4	2.9	3.0	3.3	3.1	3.0	3.2	3.3
IA2417017	3.7	3.6	3.4	3.6	3.8	3.9	4.0	4.4	5.0
IA2417055	3.2	2.8	2.5	2.5	2.7	3.1	3.0	2.8	2.5

* Forward Flow values at 1100 mbar (16 psi) air test pressure, wet with 25% (v/v) tertiary butyl alcohol in water, limit value 5.5 mL/min

1.4 Conclusions

The data presented in this section support the following conclusions:

- Emflon PFR filters show good resistance to cumulative steam exposure at 142°C (288°F).
- Emflon PFR filters are resistant to repeated thermal cycling typical of process conditions, as demonstrated by exposing filters to 165 one hour steam cycles at 142°C (288°F) (maximum differential pressure < 300 mbar (4.3 psid)).
- Emflon PFR filters are robust and capable of withstanding multiple steam sterilization cycles where the differential pressure may exceed 300 mbar (4.3 psid) in the forward direction, as demonstrated by exposing filters to high transient differential pressures of up to 1000 mbar (14.5 psid) during steaming at 125°C (257°F).
- Emflon PFR filters are capable of withstanding reverse steam sterilization conditions, including applications where the reverse differential pressure may exceed 200 mbar, as demonstrated by exposing filters to high differential pressures of up to 500 mbar (7.2 psid) in the reverse direction during steaming at 125°C (257°F).

2. Resistance to Vaporized Hydrogen Peroxide

2.1 Introduction

The aim of this series of tests was to determine the resistance of **Emflon** PFR filters to vaporized hydrogen peroxide.

2.2 Summary of Methods

Typical production filters (part number AB1PFR7PVH4) were exposed to vaporized hydrogen peroxide using a test rig, shown schematically in Figure III-2.

The upstream pipe work was trace heated and compressed air was passed through the system at a controlled flow rate. Hydrogen peroxide solution (35% concentration) was injected into the system upstream of the filter under test.

The compressed air was heated to a sufficient temperature to ensure that, on contact with hydrogen peroxide solution, vaporized hydrogen peroxide was formed. The filter under test was therefore exposed to a gaseous mixture of hydrogen peroxide vapor in air at a temperature between 80°C (176°F) and 85°C (185°F).

Downstream of the test filter, hydrogen peroxide vapor was condensed with cooling water and then sent to drain.

The conditions of exposure to vaporized hydrogen peroxide were as follows:

Volumetric gas flow:	10 m ³ /h
H₂O₂ injection rate:	5 g/min
Concentration of H₂O₂: (in air/water vapor mass/mass)	8000 ppm
Temperature:	80 – 85°C (176 - 185°F)

Resistance of the filters to hydrogen peroxide vapor was determined by measuring filter integrity using either the Forward Flow or water intrusion test methods.

Figure III-2 Schematic Representation of Test Rig

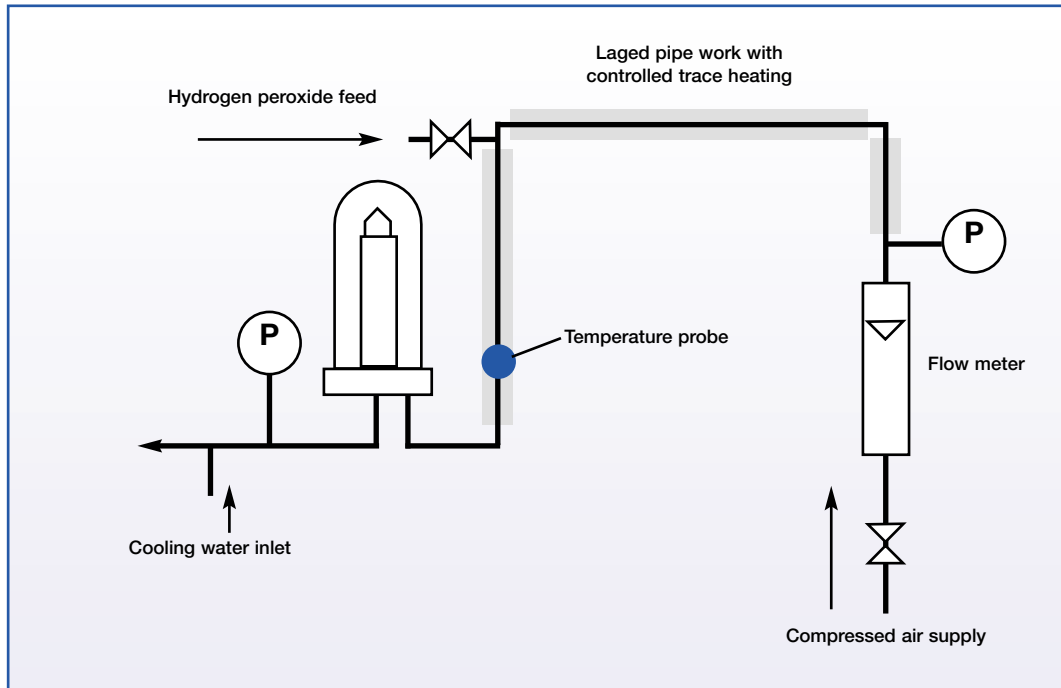

2.3 Results

The results are shown in Table III-6. All three filters exposed to vaporized hydrogen peroxide at a concentration of 8,000 ppm at 80 - 85°C (176 - 185°F) were found to retain integrity after up to 150 hours exposure.

Table III-6 Integrity Test Results for Emflon PFR Filters following Exposure to Vaporized Hydrogen Peroxide

Filter Serial Number	Exposure Time	Integrity Test Results following Exposure to H ₂ O ₂ Vapors:	
		Forward Flow*	Water Intrusion**
IB2827036	100 hours	4.0 mL/min (Pass)	0.25 mL/min (Pass)
IB2827423	40 hours	ND	0.26 mL/min (Pass)
IB1729446	100 hours	ND	0.13 mL/min (Pass)

* Forward Flow values at 1100 mbar (16 psi) air test pressure, wet with 25% (v/v) tertiary butyl alcohol in water

** Water intrusion values at 2500 mbar (36 psi) air test pressure using deionized water

2.4 Conclusions

Emflon PFR filters demonstrated excellent resistance to vaporized hydrogen peroxide and are therefore suitable for applications where sterilization by vaporized hydrogen peroxide is required.

3. Resistance to Hot Air

3.1 Introduction

The aim of this series of tests was to determine the resistance of **Emflon** PFR filters to exposure of repeated steam sterilization and high temperature air cycles. The purpose of the tests was to determine the effects of long term exposure to high temperatures on filter integrity.

3.2 Summary of Methods

Typical production filters (part number AB1PFR7PVH4) were used for the tests. Single filters were exposed to cycles of steam and hot air as shown in Table III-7.

Table III-7 Test Conditions used for Hot Air Testing Emflon PFR Filters

Steam Exposure	Hot Air Exposure			Number of Steam/Hot Air Cycles Performed
	Temp.	Flow Rate	Duration	
142°C (288°F) for one hour	120°C (248°F)	2,832 L/min (100 scfm)	Approx. 24 hours	10 cycles
142°C (288°F) for one hour	105°C (221°F)	2,124 L/min (75 scfm)	Approx. 65 hours	6 cycles
142°C (288°F) for one hour	90°C (194°F)	2,124 L/min (75 scfm)	Approx. 192 hours	6 cycles

Before and after exposure to each steam/hot air cycle, filter integrity was determined using the water intrusion test method. On completion of each cycle the filters were also visually examined for physical signs of degradation such as discoloration of the filter hardware components.

3.3 Results

The results of the hot air testing are shown in Tables III-8 to III-10. In all but one case, the filters passed the water intrusion integrity test. In one case, see Table III-9, a water intrusion test failure was recorded. This result was attributed to a test method failure rather than a filter failure as the filter passed subsequent water intrusion tests that were performed.

The data presented indicate that **Emflon** PFR filters will retain integrity following exposure of well over one year at temperatures up to 60°C (140°F). This conclusion is based on the general principle that there is a doubling in life for every 10°C (18°F) drop in temperature.

Table III-8 Water Intrusion Results for an Emflon PFR Filter* following Exposure to Repeated Hot Air Cycles at 120°C (248°F)

Cycle Number	Exposure to Air 120°C (248°F), 2832 L/min (100 scfm)	Water Intrusion Result** (mL/min)	
		Pre-Steam/ Hot Air Cycle	Post-Steam/ Hot Air Cycle
1	25 hours	0.31	0.30
2	24 hours	0.27	0.26
3	25 hours	0.26	0.29
4	26 hours	0.26	0.29
5	24 hours	0.22	0.30
6	24 hours	0.22	0.26
7	24 hours	0.20	0.26
8	24 hours	0.20	0.27
9	24 hours	0.23	0.28
10	24 hours	0.20	0.24

* Pall filter serial number IB5354334

** Air test pressure 2500 mbar (36 psi), maximum allowable flow 0.33 mL/min

Table III-9 Water Intrusion Results for an Emflon PFR Filter* following Exposure to Repeated Hot Air Cycles at 105°C (221°F)

Cycle Number	Exposure to Air 105°C (221°F), 2124 L/min (75 scfm)	Water Intrusion Result** (mL/min)	
		Pre-Steam / Hot Air Cycle	Post-Steam / Hot Air Cycle
1	65 hours	0.28	0.31
2	72 hours	0.28	Test error, ^{***} Flow too high
3	65 hours	0.27	0.27
4	65 hours	0.24	0.30
5	72 hours	0.25	0.31
6	72 hours	0.25	0.27

* Pall filter serial number IB6076503

** Air test pressure 2500 mbar (36 psi), maximum allowable flow 0.33 mL/min

*** Filter retested and passed

Table III-10 Water Intrusion Results for an Emflon PFR Filter* following Exposure to Repeated Hot Air Cycles at 90°C (194°F)

Cycle Number	Exposure to Air 90°C (194°F), 2124 L/min (75 scfm)	Water Intrusion Result** (mL/min)*	
		Pre-Steam/ Hot Air Cycle	Post-Steam/ Hot Air Cycle
1	199	0.31	0.30
2	195	0.27	0.31
3	192	0.24	0.30
4	192	0.29	0.31
5	192	0.27	0.31
6	192	0.27	0.30

* Pall filter serial number IB5949224

** Air test pressure 2500 mbar (36 psi), maximum allowable flow 0.33 mL/min

3.4 Conclusions

The data presented demonstrate that **Emflon** PFR filters are suitable for use in hot air environments. Based on cyclic exposure to steam and hot air the results indicate that **Emflon** PFR filters will retain integrity following exposure of well over one year at 60°C (140°F).

4. Air Flow/Differential Pressure Characteristics

4.1 Introduction

The aim of these tests was to determine the pressure differential characteristics of the filter when subjected to different air flow rates at different inlet pressures.

4.2 Summary of Methods

Standard production filters (part number AB1PFR7PVH4) were installed in a stainless steel air filter housing designed for use in compressed gas and vent applications. The differential pressure across the filter assembly (filter housing and filter cartridge) was measured while clean compressed air was directed through the filter assembly, at a range of flow rates and under both 'atmospheric vent' and 'pressurized' operating conditions.

In 'vent' conditions, the downstream side of the filter assembly was open to atmospheric pressure and air flow through the filter was controlled from the upstream side. Under 'pressurized' conditions, predetermined air pressures were maintained upstream of the filter assembly; air flow rate through the filter was controlled by restricting flow on the downstream side.

All air flow measurements were corrected to standard conditions (1013.25 mbar, 20°C (68°F)).

Please contact Pall if further details about the test methods are required.

4.3 Results

The flow versus differential pressure values at atmospheric pressure and various applied upstream pressures (1,2,3 and 4 bar gauge) are shown in Figure III-3. These data show that there is a non-linear relationship between flow and pressure differential. These data form the basis of sizing filter systems using **Emflon** PFR filter cartridges.

Figure III-3 Air Flow/Differential Pressure Characteristics of Emflon PFR Filters/Housing System*

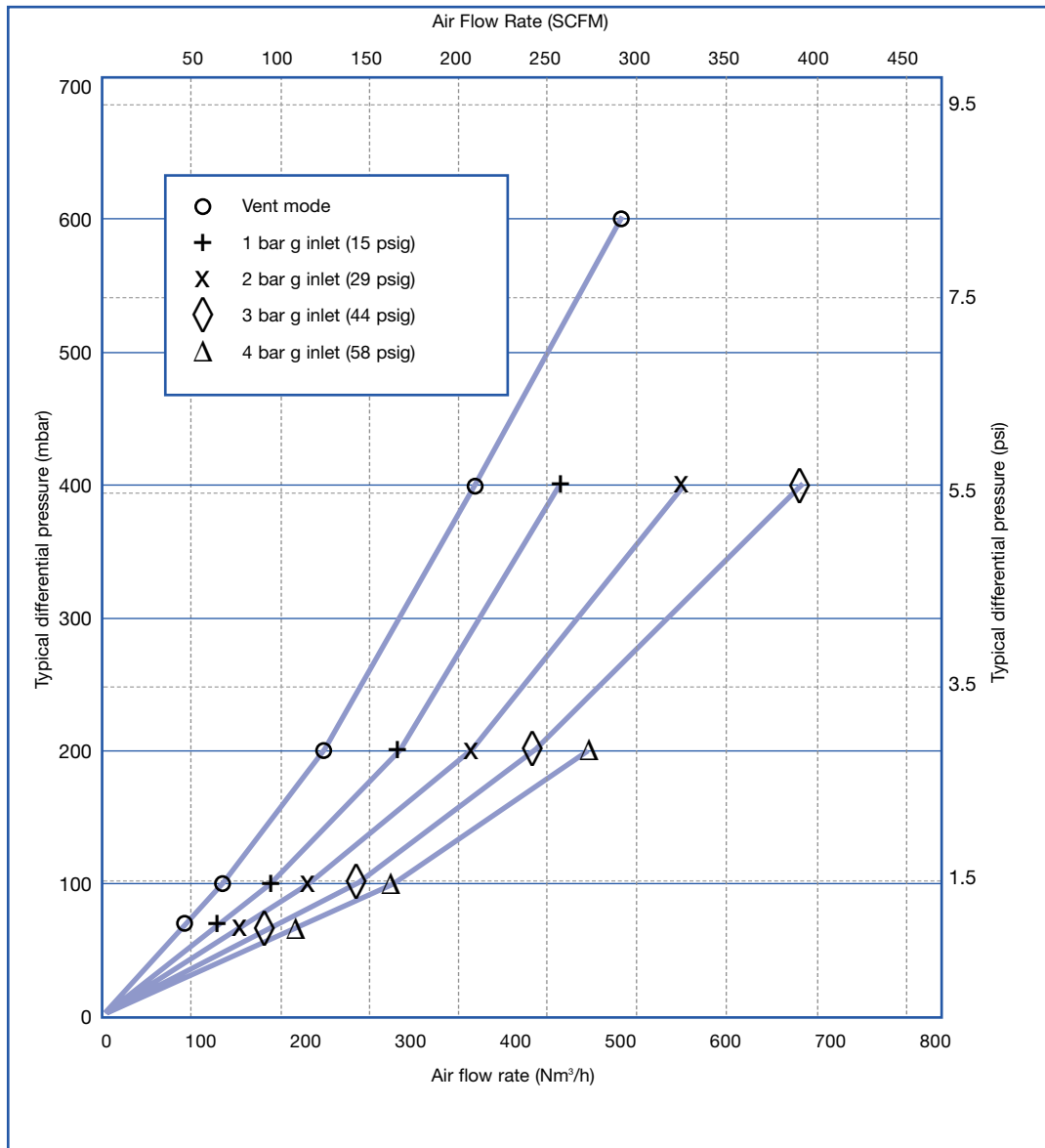

* AB1PFR7PVH4 filter in ECS6001G54H4 filter housing with 50 mm (2" connections).

4.4 Conclusions

The non-linear relationship between flow and pressure differential demonstrates that turbulent flow is present due to pressure losses in the filter core, adapter, housing inlet/outlet ports etc. The filter membrane component however would be expected to give a linear relationship due to laminar flow through the filter matrix. These properties must be considered when sizing **Emflon** PFR filter systems.

5. Water Flow/Differential Pressure Measurements

5.1 Introduction

The aim of these tests was to determine the water flow rates at set differential pressures across **Emflon** PFR filters.

5.2 Summary of Methods

The tests were performed on standard production filters (part number AB1PFR7PVH4). Test filters were installed in a stainless steel housing and flushed with isopropyl alcohol to pre-wet the filter membranes. Pre-filtered deionized water was then pumped through the assembly in the normal flow ('out to in') direction. Pressure transducers on the upstream and downstream side of the test filter housing were monitored to calculate the differential pressure at different water flow rates.

Further measurements were taken with the housing only (no filter installed). The housing-only results were subtracted from the filter assembly results in order to provide flow/pressure characteristics for the filter only. All data were corrected to a standard temperature of 20°C (68°F).

Please contact Pall if further details about the test methods are required.

5.3 Results

The water flow measurements through typical 25 cm **Emflon** PFR filters at 300 mbar (4.3 psid) differential pressure are shown in Table III-11.

Table III-11 Water Flow Rates through Typical 25 cm (10") Emflon PFR Filters

Filter Serial Number	Water Flow at 300 mbar (4.3 psid) Differential Pressure
IB0584136	36 L/min (9.5 gpm)
IB0584147	38 L/min (10 gpm)
IB0584110	40 L/min (10.6 gpm)

5.4 Conclusions

The water flow rates at 300 mbar (4.3 psid) differential pressure for **Emflon** PFR filters (part number AB1PFR7PVH4) were found to range between 36 - 40 L/min. These data can be used to form the basis of sizing filter systems using **Emflon** PFR filters.

Note: The differential pressures quoted are for liquids with a viscosity of 1cP. Differential pressures for liquids at other viscosities can be estimated by multiplying the differential pressure by the viscosity in cP. To obtain the total pressure drop of a complete filter assembly the housing pressure drop must also be added. Please contact Pall for further details.

Part IV. Extractables and Biological Safety Testing

1. Extractables Testing of Emflon PFR Filters

1.1 Introduction

The aim of this series of tests was to quantify the material, which can be extracted from **Emflon** PFR filters using water, isopropyl alcohol, ethanol and diethyl ether.

1.2 Summary of Methods

Preparation of Filter Samples

Extractables tests were performed on typical production filter cartridges, which had been autoclaved in order to maximize the quantity of any extractable material present. The filters were wrapped in aluminium foil and autoclaved for one hour at 121°C (250°F), using a slow exhaust cycle. Visible droplets of water remaining on the filter elements were allowed to evaporate at room temperature before the extraction was performed.

Extraction Procedure

Dynamic extraction tests were performed. The test filters were immersed in 1500 mL of extraction fluid in a clean measuring cylinder, as shown in Figure IV-1. For four hours, the filter was gently moved up and down. This movement created flow through the filter membrane because of the pressure head that was created each time the element was partially lifted out of the liquid. (During the tests with water, flow through the filter membrane did not occur due to the hydrophobic nature of the membrane).

Figure IV-1 Filter Extraction Equipment

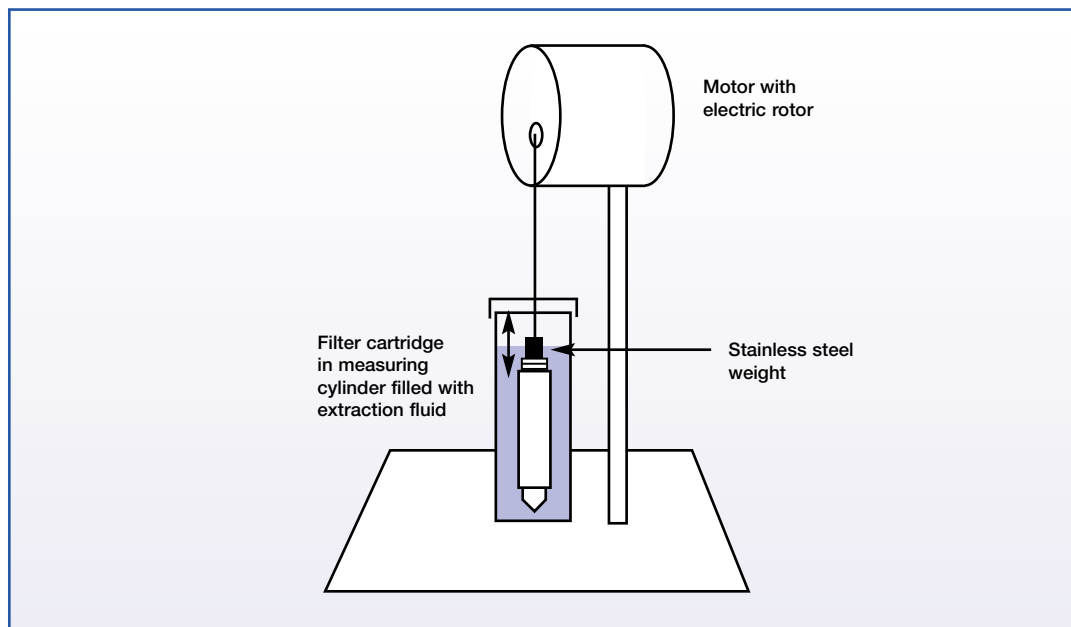

Analysis of Material Extracted

After the extraction, 1000 mL of the extraction liquid was evaporated to dryness and the non-volatile extractables were determined gravimetrically.

The material extracted by diethyl ether were analyzed by Fourier Transform Infra Red spectroscopy.

Please contact Pall if further details of the test methods are required.

1.3 Results

Table IV-1 shows the levels of extractables obtained using typical production **Emflon** PFR filters (part number AB1PFR7PVH4).

Infra red spectra of diethyl ether extracts from **Emflon** PFR filters (see Figure IV-2) showed close similarities with those of polypropylene.

Table IV-1 Non-volatile Extractables using Typical 25 cm (10") Emflon PFR Filters

Extraction Fluid	Filter Serial Number	Residue
Deionized water	IA3651072	3 mg
	IA3651008	1 mg
Isopropyl alcohol	IB1729537	16 mg
	IB1729538	17 mg
	IB1729543	15 mg
Ethanol	IB5354328	59 mg
	IB5354340	34 mg
	IB5354497	41 mg
Diethyl ether	IB5354001	382 mg
	IB5354523	509 mg
	IB53547081	599 mg

Figure IV-2 Infra Red Spectrum of Diethyl Ether Extracts from Emflon PFR Filters

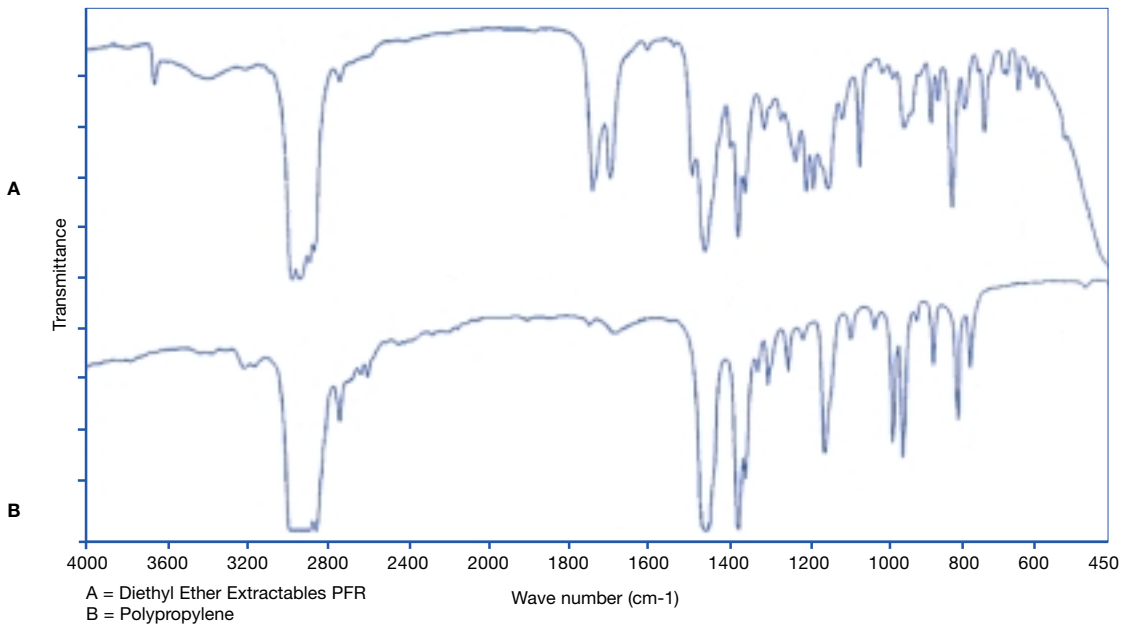

1.4 Conclusions

The levels of extractables determined for **Emflon** PFR filters were dependent on the solvent used. For most solvents tested, the gravimetric extractables were found to be extremely low. The results reported are typical for production elements.

Actual service will impose different conditions, such as different exposure times, temperature, liquid purity etc. Evaluation under process conditions is therefore also recommended.

2. Biological Safety Tests on Components of Emflon PFR Filter Cartridges

2.1 Introduction

The purpose of these tests was to evaluate the biological suitability of the materials of construction of the **Emflon** PFR filters. The materials of construction of **Emflon** PFR filters are as follows :

Filter medium:	Double layered PTFE membrane
Support/drainage layers:	Natural unpigmented polypropylene homopolymer
Endcap/adapter:	Natural unpigmented polypropylene homopolymer
Core/cage:	Natural unpigmented polypropylene homopolymer

2.2 Summary of Methods

The tests were performed in accordance with the Biological Reactivity Tests *in vivo* for Class VI Plastics (121°C) as described in the current United States Pharmacopeia. The tests were conducted by South Mountain Laboratories, 380 Lackawanna Place, South Orange, New Jersey 07079.

The testing procedures described in the USP include:

- Injection of extracts of plastic materials
- Implantation of the solid material into animal tissue

The four extracting media listed in the USP simulate parenteral solutions and body fluids. These include:

- Sodium Chloride Injection
- 1 in 20 Solution of Alcohol in Sodium Chloride Injection
- Polyethylene Glycol 400
- Vegetable Oil (sesame or cottonseed oil)

The USP states that extracts may be prepared at one of three standard conditions: 50°C (122°F) for 72 hours, 70°C (158°F) for 24 hours, or 121°C (250°F) for 1 hour. The most stringent condition not resulting in physical changes in the plastic is recommended, therefore the filters were extracted at 121°C (250°F).

Acute Systemic Injection Tests

An Acute Systemic Injection Test was performed to evaluate the potential of a single injection of an extract to produce systemic toxicity. Sodium Chloride Injection and 1 in 20 Solution of Alcohol in Sodium Chloride Injection were injected intravenously. Vegetable oil extract and Polyethylene Glycol 400 extract were injected intraperitoneally.

Intracutaneous Tests

An Intracutaneous Test was performed to evaluate the potential of a single injection of an extract to produce tissue irritation. All four of the extracts listed above were used for these tests.

Implantation Tests

Implantation tests were also performed, in order to subject the materials of construction to the most stringent conditions included in the USP. Each of the components of the **Emflon** PFR membrane filter cartridges was implanted separately.

2.3 Results

The **Emflon** PFR membrane filters passed all of the tests specified. Appendix 1 shows a copy of the test certificate. Please contact Pall if copies of the test reports are required.

2.4 Conclusions

Emflon PFR membrane filters meet the requirements of the USP for Class VI (121°C) Plastics.

Appendix 1

SOUTH MOUNTAIN LABORATORIES, INC.
380 LACKAWANNA PLACE SOUTH ORANGE, NJ 07079

DATE: December 1, 1995 SM #9503964

SPONSOR: Janet Mathus
Fall Corporation
25 Harbor Park Drive
Port Washington, NY 11050

PRODUCT: Fall Emlon PFR Filter
P.O. #98016

RE: CLASS VI PLASTIC - 121C

REQUIRED: Systemic Injection Test
Intracutaneous Test
Implantation Test

METHOD: U.S.P. XXIII

EXTRACTS: 1. Sodium Chloride Injection
2. 1 in 20 Solution of Alcohol in
Sodium Chloride Injection
3. Polyethylene Glycol-400
4. Sesame Oil

RESULTS:

Systemic Injection Test MEETS the requirements.
Intracutaneous Test MEETS the requirements.
Implantation Test MEETS the requirements.

The data for each test is attached.

Analyst: David A. Heath 12/1/95

Reviewed by: Barbara Peterson 12/1/95

pa



Life Sciences

New York - USA

+1 516 484 5400 phone

+1 516 625 3610 fax

pharmafilter@pall.com e-mail

Portsmouth - Europe

+44 (0)23 9230 3303 phone

+44 (0)23 9230 2506 fax

BioPharmUK@europe.pall.com e-mail

Filtration. Separation. Solution.SM

Visit us on the web at www.pall.com/biopharmaceutical

Pall Corporation has offices and plants throughout the world in locations including: Argentina, Australia, Austria, Belgium, Brazil, Canada, China, France, Germany, India, Indonesia, Ireland, Italy, Japan, Korea, Malaysia, Mexico, the Netherlands, New Zealand, Norway, Poland, Puerto Rico, Russia, Singapore, South Africa, Spain, Sweden, Switzerland, Taiwan, Thailand, United Kingdom, the United States and Venezuela. Distributors are located in all major industrial areas of the world.

Because of developments in technology these data or procedures may be subject to change. Consequently we advise users to review their continuing validity annually. **PALL**, Pall, Palltronic, Emlon and Novasip are trade marks of Pall Corporation.
Filtration. Separation. Solution. is a service mark of Pall Corporation.
® indicates a trademark registered in the USA.
© 2003, Pall Europe Limited.